



Installation Instructions I-1000

The Shurjoint Installation Instructions I-1000 covers the latest technical information on Shurjoint products including newly added products, correction of typographical errors in the previous edition and revisions of torque values and other technical data. Thus, all the data and descriptions contained in this edition supersede any preceding editions of Shurjoint catalogs, brochures and installation instructions.

All rights reserved. No part of this publication may be reproduced, stored in a retrieval system, or transmitted in any form or by any means, without the prior permission in writing of Shurjoint Piping Products.

To ensure correct installation and operation of your Shurjoint product(s), read this manual carefully before installation, assembly or use. Keep this manual on hand for future reference. For the latest updates and products not covered in this manual please refer to our website; www.shurjoint.com

INSTALLATION INSTRUCTION HAND BOOK

- TABLE OF CONTENTS -

TABLE OF CONTENTS	1
INTRODUCTION.....	6
General Notes.	6
Hazard Identification	7
PIPE END PREPARATION.....	8
Check your pipe O.D.	8
What pipe can be roll or cut grooved?.....	9
About roll-grooving	10
About cut-grooving.....	11
GROOVE DIMENSIONS	12
General Notes for Roll Groove Dimensions.....	12
Roll Grooving Dimensions	
Roll Grooving Dimensions -	
ANSI B36.10, BS 1387(M), AS 1074(M) Pipe.....	14
Standard roll groove - Large diameter IPS pipe ANSI B36.10.....	18
Standard roll groove specification - ISO/FDIS 6182-12 Table 1.....	20
Standard roll groove specification - KS D3507 / JIS G3452.....	22
Standard roll groove - U.S. Standard copper tubing.....	23
Standard roll groove - BS EN 1057 copper tubing	23
General Notes for Cut Groove Dimensions	24
Cut Grooving Dimensions – IPS / BS / AS / ISO / JIS / KS Pipe	26
"EP" End Protection Cut Groove Specification	
for XH-1000 / XH-70EP coupling (IPS sizes)	30

Radius Cut Grooving Dimensions for AWWA ductile iron pipe	32
BOLTS & NUTS	34
Carbon Steel Bolts & Nuts	34
Recommended Bolt Torque	34
Helpful Information to Ensure Proper Assembly	35
RUBBER GASKETS	36
Grades and Recommended Services	36
Gasket Selection Guide	36
Gasket styles	36
Vacuum service	38
Dry pipe and freezer services	38
ANSI/NSF 61 Standard	38
Lubricant	38
Gasket Grade Index	39
Special Gaskets for AWWA Ductile Iron Pipe	40
General Gasket Service Recommendations	41
INSTALLATION INSTRUCTIONS	49
Grooved Couplings	50
How to Install Gasket - Preliminary Steps	50
#Z07, #Z07N & #Z05 Angle Pad Rigid Couplings	51
#7705, #7705H & #7707 Couplings	53
#K-9, #K-9H & #7771 Rigid Couplings	55
#7771-T Transition Coupling	55
#R20 Rigid Coupling	58
#G-28 Hinged Lever Coupling	60
#XH-70EP Extra Heavy Rigid Coupling	62
#XH-1000 Extra Heavy Rigid Coupling	64

#7706, #7706-T Reducing Couplings	66
#C-7 & #C-7G Outlet Couplings.....	69
#7041 & #7043 (2" -12") Flange Adapters	71
#7041N (14" - 24") Flange Adapter	73
#7041 (14" - 24") Flange Adapter	75
#7041 & #7043 Flange Adapters, Important Notes	78
Hole-Cut Piping System	80
Hole Sizes for #7721, #7722, #M21 & #M22	81
#7721 & #7722 Mechanical Tees.....	82
#M21 & #M22 Mechanical Tees.....	85
#723 & #SS-723 Saddle-let Small Mechanical Tees.....	88
Stainless Steel Couplings.....	91
How to Install Gaskets - Preliminary Steps	91
#SS-5 Stainless Steel Angle Pad Rigid Couplings	93
#SS-7 & #SS-7X Stainless Steel Rigid Couplings	95
#SS-8 & #SS-8X Stainless Steel Standard Couplings	98
#SS-1200 Stainless Steel Flexible Coupling	99
#SS-28 Stainless Steel Hinged Lever Coupling	101
#SS-41 Flange Adapter - ANSI 125 / 150	103
Copper Tubing Series.....	106
How to Install Gaskets - Preliminary Steps	106
#C305 Rigid Coupling.....	108
#C306 Reducing Coupling	110
#C307 Transition Coupling.....	113
#C341 Flange Adapter	116
#C723 Bronze Mechanical Tee.....	119
Plain-End IPS Piping System.....	122
#79 "Wildcat" Coupling	122
Plain-End HDPE Piping System.....	125
#H305 HDPE Coupling.....	127
#H307 HDPE Transition Coupling.....	131

#H312 HDPE Flange Adapter.....	134
AWWA Ductile Iron Series	137
How to Install Gaskets - Preliminary Steps	137
# A505 Coupling.....	139
# A507 Transition Coupling	140
# A512 (2" - 12") Flange Adapter.....	142
# A512 (14" - 24") Flange Adpater	144

APPENDIX 147

Pressure Performance Data

Ductile Iron Couplings on Carbon Steel and/or Stainless Steel Pipe.....	148
Models Z05 / K-9 / Z07 / 7771 / XH-1000 / G28 / 7705 / 7707 / 7706 / C-7 / 7043 / 7041 / 7707N / 7707L / Z07N	
Stainless Steel Couplings on Stainless Steel Pipe.....	165
Models SS-7 / SS-5 / SS-7X / SS-8 / SS-8X / SS-1200 / SS-28	

Product data..... 167

Grooved Couplings.....	168
Models Z07 / Z05 / 7705 / 7707 / G-28 / K-9 / 7771 / XH-70EP / XH-1000 / R20 / 7706 / 7771-T / C-7	
Grooved Mechanical Tees.....	174
Models 7721 / M21 / 7722 / M22 / 723	
Grooved Flange Adapters.....	176
Models 7180 / 7181 / 7041 / 7041N / 7043	
Grooved Fittings.....	178
Models 7110 / 7111 / 7112 / 7113 / 7120 / 7135 / 7130 / W110LR / W111LR / W120 / 7121 / W121 / 7150 / 7151 / W150 / W151 / 7110LR / 7111LR / 7137 / 7160 / 7160P / 7160H / W160 / 7110-B / 56 / 901 / 903 / 7110DR / 7150F / 7150M / 7160T / 55 / 57 / 58 / 59 / 7127 / 7125 / 899 / 7114 / 7122 / 7133 / 10EP / 11EP / 20EP / 35EP / 22EP / L90-3D / L60-3D / L45-3D / L30-3D / L22-3D / L11-3D / L90-5D / L60-5D / L45-5D / L30-5D / L22-5D / L11-5D /	

L90-6D / L60-6D / L45-6D / L30-6D / L22-6D / L11-6D / 850 / 851 / 853	
Stainless Steel Series.....	205
Models SS-5 / SS-7 / SS-8 / SS-8X / SS-1200 / SS-41 / SS-80 / SS-28 / SS-7X /	
SS-723 / SS-21 / SS-50 / SS-10 / SS-11 / SS-20 / SS-60 / WS-10 / WS-10L /	
WS-11 / WS-20 / WS-60 / WS-21 / WS-50	
Plain-End Piping System.....	213
Model 79.....	213
Models H305 / H307 / H312 / H305 ISO / H307 ISO / H312 ISO.....	213
Copper Series.....	215
Models C305 / C307 / C341 / C306 / C723 / C10 / C11 / C20 / C60 / C21 / C50 /	
C26 / C52 / C55 / DE30-GG	
AWWA Ductile Iron Series.....	219
Models A505 / A507 / A512 / A10 / A11 / A12 / A13 / A20 / A60 / A25 /	
A50 / A10R	
Helpful Information.....	221
Metric/Imperial Conversion Chart.....	222
Decimal Equivalent of Fractions (inches).....	223
Minutes Converted to Decimals of a Degree.....	224
Water Pressure to Feet-of-Head.....	225
Feet-of-Head of Water to Pressure.....	225
Pipe Sizes & Wall Thickness.....	226
ANSI Commercial Pipe Sizes Chart.....	226
Pipe Dimensions to AS 1074.....	230
Pipe Dimensions to EN 10255:2004.....	230
Copper Tubing Sizes & Wall Thicknesses.....	231
Copper Tube Type K, M, L, DWV.....	231
Bolt & Socket Sizes.....	232
Hangers for Straight Runs.....	239

INTRODUCTION

Thank you for selecting a Shurjoint product. This manual covers the proper installation and assembly procedures for your product. To ensure the proper installation, assembly and performance of the product, read this manual thoroughly before the installation of any product and keep this manual on hand for future reference.

This manual covers carbon steel and stainless steel pipe of IPS, BS, DIN (ISO), AS, JIS, and KS pipe dimensions, ductile iron pipe of AWWA and BS EN dimensions, copper tubing of ASTM, BS and AS dimensions.

Shurjoint grooved couplings, flange adapters and grooved end fittings are manufactured for use with standard roll or cut grooves as specified in ANSI/AWWA C606 (latest edition) and ISO/FDIS 6182-12. For other pipe sizes not specified in ANSI/AWWA C606 (latest edition) and ISO/FDIS 6182-12, refer to the relative groove specifications shown in this manual or Shurjoint catalog.

In addition to this handbook, Shurjoint offers installation instructions for Valves, Ring Joint System, Threaded Fittings and Expansion Joints on the World Wide Web at www.shurjoint.com.

If additional or more detailed information is required please contact your local Shurjoint Distributor.

General Notes

1. Always read this installation manual before installing any product.
2. To avoid serious personal injury, wear safety glasses, hard hat and foot protection.
3. Designers must know and understand all relevant building and/or piping standards, codes and other specifications. It is the responsibility of the designer to select and/or specify the appropriate products for the intended use and service.
4. Always refer to the maximum pressure rating and range of service temperatures allowed for the Shurjoint products and ensure that they are used within these limitations.
5. Always depressurize and drain the piping system before attempting disassembly, adjustment or removal of any piping component. Failure to do so may result in serious personal injury.
6. The pipe groove dimensions must be in accordance with Shurjoint Cut Groove or Roll Groove specifications. Refer to page 10 to 33 or visit Shurjoint website, www.shurjoint.com for details.
7. Ensure that the coupling keys are engaged in the grooves.

8. Always tighten nuts evenly by alternating sides. Uneven tightening can cause the gasket to pinch or bind. If a gasket becomes pinched, replace immediately.
9. Special attention is required for selection of suitable rubber gaskets for the intended service. To prevent deterioration of the gasket material, a petroleum lubricant should never be used. Use a recommended lubricant to install the gasket.
10. Torque values are supplied as a guideline and may be used when setting the torque on power impact wrenches. Always refer to the power impact wrench manufacturer's instructions for settings.
11. Exceeding the suggested torque values may cause damage to the coupling and/or result in pipe-joint failure. Minimum bolt torque is required for coupling to meet the published performance parameters.
12. All information and data contained herein supersedes all previous published data. Shurjoint reserves the right to change product designs and/or specifications without notice and/or obligation.

Hazard Identification

Please notice the definitions for various hazard levels below.

WARNING

The use of the word "WARNING" identifies the presence of hazards or unsafe practices that could result in death or serious injury if instructions, including recommended precautions, are not followed.

CAUTION

The use of the word "CAUTION" identifies possible hazards or unsafe practices that could result in personal injury and product or property damage if instructions, including recommended precautions, are not followed.

The use of the word "NOTE" identifies special instructions that are important but not related to hazards.

Pipe End Preparation

Check pipe O.D.

Check to insure that the pipe to be prepared has the proper O.D. and wall thickness for the intended service.

While Shurjoint fittings are normally identified by the nominal size, always check the actual O.D. of the pipe and fittings to be connected, as in some markets it is customary to refer to different O.D. pipes with the same nominal size.

For example: The nominal size 65 (2-1/2") is referred to 2.875"(73.0 mm) pipe O.D. in IPS and 3.000"(76.1 mm) pipe O.D. in AS, BS, DIN (ISO), JIS or KS pipes.

IPS - United States Standard (Inch)

AS - Australian Standard (Metric)

BS - British Standard (Metric)

DIN - German Standard (Metric)

JIS - Japanese Industrial Standard (Metric)

KS - Korean Standard (Metric)

Sizes - Inches		Sizes - Millimeters	
Nominal Size	Actual Size	Nominal Size	Actual Size
1/2	0.840	15	21.3
3/4	1.050	20	26.7
1	1.315	25	33.4
1 1/4	1.660	32	42.2
1 1/2	1.900	40	48.3
2	2.375	50	60.3
2 1/2	2.875	65	73.0
3 O.D.	3.000	65	76.1
3	3.500	80	88.9
3 1/2	4.000	90	101.6
4 1/4 O.D.	4.250	100	108.0
4	4.500	100	114.3
5	5.563	125	141.3
5 1/4 O.D.	5.250	125	133.0
5 1/2 O.D.	5.500	125	139.7
6 1/4 O.D.	6.250	150	159.0
6 1/2 O.D.	6.500	150	165.1
6	6.625	150	168.3
8 J/K*	8.516	200	216.3*
8	8.625	200	219.1
10 J/K*	10.528	250	267.4*
10	10.750	250	273.0
12 J/K*	12.539	300	318.5*
12	12.750	300	323.9
14	14.000	350	355.6
16	16.000	400	406.4
18	18.000	450	457.2
20	20.000	500	508.0
22	22.000	550	558.8
24	24.000	600	609.6
28	28.000	700	711.2
30	30.000	750	762.0
32	32.000	800	812.8
36	36.000	900	914.4
40	40.000	1000	1016.0
42	42.000	1050	1066.8

* JIS/KS

What pipe can be roll or cut grooved ?

Shurjoint grooved piping systems require a roll or cut-groove to be applied to the pipe ends being connected. The groove dimensions and configurations may vary depending on several factors including pipe material, wall thickness and desired working pressures. Roll grooving is the most common practice and can be performed in the fabrication shop or in the field or the job site. Cut grooving on the other hand is primarily performed at the factory or fabrication shop, as cut grooving machines are not as common or portable as roll grooving machines. All roll and cut grooves must meet the specifications and requirements of ANSI/AWWA C606 (latest edition) and ISO/FDIS 6182-12. For other pipe sizes not specified in ANSI/AWWA C606 (latest edition) and ISO/FDIS 6182-12, refer to the relative groove specifications shown in this manual or Shurjoint catalog. When grooving pipe, it is preferable to start with plain-end pipe, although in some cases the use of beveled pipe is acceptable providing that the wall thickness is standard or thinner and the bevel is $37\frac{1}{2}^\circ \pm 2\frac{1}{2}^\circ$ (ANSI B16.25). Spiral welded pipe may also be used as long as the welding beads are removed from all of the sealing and seating surfaces.

Roll & Cut-Grooving Applications		
Pipe Materials	Roll Groove	Cut Groove
Carbon Steel Pipe	Standard wall, Sch. 40 (10" and below), 30, 20, 10, 7, 5, BS1387 Medium & Light, JIS SGP	Sch. 80, 40, 30 BS1387 Medium & Heavy, JIS SGP
Stainless Steel Pipe	Sch. 40S, 20S, 10S, 5S	Sch. 80S, 40S
Copper Tubing	K, L, M, DWV, AS	Not applicable
Aluminum Pipe	Sch. 40, 30, 20, 10	Sch. 80, 40, 30
PVC Pipe	Sch. 80, 40	Sch. 80, 40
Ductile Iron Pipe	Not applicable	Class 54 (See ANSI/AWWA C606 (latest edition) Tables 2 & 3)

About roll-grooving

Roll grooving was first used with light or thin wall pipe, which had insufficient wall thickness for cut grooving. Today roll grooving is commonly used on standard and Schedule 40 wall pipe (max. 9.5 mm thick) for sizes to 42"(1050 mm) depending on the type of roll-grooving machine and roll sets used.

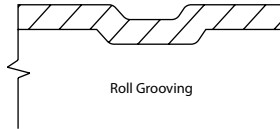

Roll grooving radially displaces the pipe material. Because roll grooving removes no material from the pipe itself, the integrity of the pipe remains intact when properly grooved. The inside protrusion or upset of roll groove is small and smooth at its entry and exit and thus has insignificant or negligible effect on both flow and/or line pressure. Roll grooving is limited to pipe having a hardness of HB180 or less.

To groove the pipe, the end is placed between a roll set and as the roll set is compressed and rotated a groove is processed around the diameter of the pipe, recessed on the outside and protruding on the inside. Roll grooving can be processed on carbon steel, stainless steel, copper and aluminum pipe. Care must be taken to use the proper equipment and roll sets for the piping material being grooved. Different materials can require the use of different roll sets as in the case with copper, stainless steel and heavy wall (9.5 mm thick) carbon steel pipe. Consult your grooving machine / roll set instructions or operators manual or contact Shurjoint for more information.

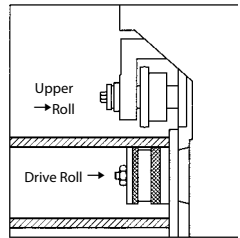

Pipe end is placed between the roll set (upper roll & drive roll)

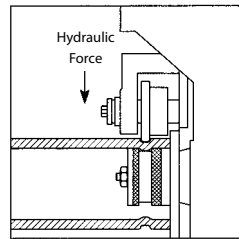

A groove is processed as the roll set is compressed and rotated

 Refer to roll groove dimensions section

About cut-grooving

The cut grooving process actually removes material from the pipe O.D. to form a groove. Thus cut grooving is intended for use with standard and heavier wall pipe. Most all pipes which are designed to be threaded can be cut grooved, as the depth of a cut groove is typically less than that of a standard thread. Please refer to the minimum wall thickness shown in the published standard cut groove specifications.

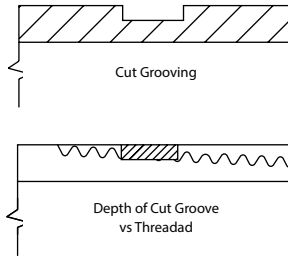

Unlike with roll-grooving, cut grooving produces a square cut groove in the pipe, without any protrusion on the inside of the pipe. Cut grooving is commonly used on piping components such as 90° elbows, tees, grooved-end valves, etc. It is also good practice to process a cut groove into plastic-coated or cement-lined pipe as roll grooving may damage the internal coatings or linings of such pipe. The cut grooving process typically uses cutting oils to cool and assist in the cutting process. Residual oils must be removed as they are not compatible and could cause damage to some rubber gasket compounds. Ductile iron pipe must be cut grooved using a radius cut groove in accordance with ANSI/AWWA C606 (latest edition).

 Refer to cut groove dimensions section

Groove Dimensions

General Notes for Roll Groove Dimensions

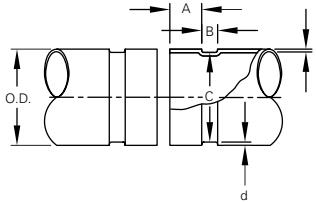

Standard Roll Groove

Nominal Size: Shurjoint couplings and fittings are identified by the nominal IPS pipe size in inches or nominal outside diameter of pipe in millimeters

O.D.: Pipe ends must be square cut. The maximum allowable tolerances from square ends is 0.03"(0.8 mm) for sizes up to 3½", 0.045" (1.2 mm) for 4" thru 6" and 0.060"(1.6 mm) for sizes 8" and above.

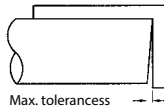

Gasket Seating Surface ("A" Dimension): The exterior surface of the gasket seating area shall be free from any indentations, projections, roll marks or other harmful surface defects such as loose paint, scale, dirt, chips, grease and rust.

Groove Width ("B" Dimension): is to be measured between vertical flanks of the groove side walls, and is determined by the width of the upper roller as it is pressed into the pipe. Visually inspect the pipe groove to insure the groove has well defined edges for the coupling keys to engage properly. If they appear to be rounded with little or no vertical lip, they should be replaced as this could lead to reduced product performance or joint failure.

Groove Diameter ("C" Dimension): are given in the tables on the following page.

These should be inspected for dimensional accuracy to insure proper product performance of the couplings, to the required systems pressures. The groove diameters are average values. The groove must be of uniform depth around the entire pipe circumference.

Minimum Wall Thickness ("t" Dimension): The "t" is the minimum allowable wall thickness that may be roll-grooved.

Groove Depth ("d" Dimension): The values listed in the Groove Specification tables are for reference only.

Flare Diameter ("F" Dimension): The pipe end that may flare when roll grooved shall measure within this limit when measured at the extreme end of the pipe.

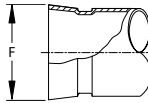

Roll Grooving Dimensions for ANSI B36.10, BS 1387 (M) & AS 1074 (M) Pipe

Basic roll groove dimensions conform to ANSI/AWWA C606-06 Table 5 with slightly adjusted tolerances to incorporate international standards including CSA B242, ISO/FDIS 6152-12, VdS 2100-6en and JPF MP-006.

Nominal Size in / mm	Pipe O.D.			A ±0.030 / ±0.76 in / mm	B ±0.030 / ±0.76 in / mm
	Basic in / mm	Tolerance			
		in / mm	in / mm		
¾	1.050	+0.010	-0.010	0.625	0.281
20	26.7	+0.25	-0.25	15.88	7.14
1	1.315	+0.013	-0.013	0.625	0.281
25	33.4	+0.33	-0.33	15.88	7.14
1¼	1.660	+0.016	-0.016	0.625	0.281
32	42.2	+0.41	-0.41	15.88	7.14
1½	1.900	+0.019	-0.019	0.625	0.281
40	48.3	+0.48	-0.48	15.88	7.14
2	2.375	+0.024	-0.024	0.625	0.344
50	60.3	+0.61	-0.61	15.88	8.74
2½	2.875	+0.029	-0.029	0.625	0.344
65	73.0	+0.74	-0.74	15.88	8.74
76.1 mm	3.000	+0.030	-0.030	0.625	0.344
	76.1	+0.76	-0.76	15.88	8.74
3	3.500	+0.035	-0.031	0.625	0.344
	88.9	+0.89	-0.79	15.88	8.74
101.6 mm	4.000	+0.040	-0.031	0.625	0.344
	101.6	+1.02	-0.79	15.88	8.74
108.0 mm	4.250	+0.042	-0.031	0.625	0.344
	108.0	+1.07	-0.79	15.88	8.74
4	4.500	+0.040	-0.031	0.625	0.344
	114.3	+1.02	-0.79	15.88	8.74
133.0 mm	5.250	+0.051	-0.031	0.625	0.344
	133.0	+1.32	-0.79	15.88	8.74
139.7 mm	5.500	+0.050	-0.031	0.625	0.344
	139.7	+1.40	-0.79	15.88	8.74
5	5.563	+0.056	-0.031	0.625	0.344
	141.3	+1.42	-0.79	15.88	8.74
159.0 mm	6.250	+0.063	-0.031	0.625	0.344
	159.0	+1.60	-0.79	15.88	8.74
165.1 mm	6.500	+0.063	-0.031	0.625	0.344
	165.1	+1.60	-0.79	15.88	8.74
6	6.625	+0.063	-0.031	0.625	0.344
	168.3	+1.60	-0.79	15.88	8.74
216.3 mm	8.516	+0.063	-0.031	0.750	0.469
	216.3	+1.60	-0.79	19.05	11.91
8	8.625	+0.063	-0.031	0.750	0.469
	219.1	+1.60	-0.79	19.05	11.91
10	10.750	+0.063	-0.031	0.750	0.469
	273.0	+1.60	-0.79	19.05	11.91
12	12.750	+0.063	-0.031	0.750	0.469
	323.9	+1.60	-0.79	19.05	11.91
14	14.000	+0.063	-0.031	0.938	0.469
	355.6	+1.60	-0.79	23.83	11.91

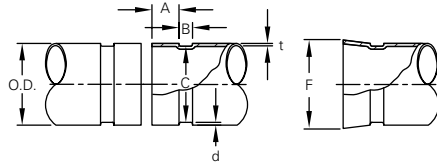

C +0.000 / +0.00 in / mm	t Min. Wall in / mm	d Groove Depth (ref.) in / mm	F Max. Allowed Flare Dia. in / mm	Nominal Size in / mm
0.938-0.015	0.065	0.056	1.15	¾
23.83-0.38	1.65	1.42	29.21	20
1.190-0.015	0.065	0.063	1.43	1
30.23-0.38	1.65	1.60	36.30	25
1.535-0.015	0.065	0.063	1.77	1¼
38.99-0.38	1.65	1.60	44.96	32
1.775-0.015	0.065	0.063	2.01	1½
45.09-0.38	1.65	1.60	51.05	40
2.250-0.015	0.065	0.063	2.48	2
57.15-0.38	1.65	1.60	62.99	50
2.720-0.018	0.083	0.078	2.98	2½
69.09-0.46	2.11	1.98	75.69	65
2.844-0.018	0.090	0.075	3.10	
72.26-0.46	2.30	1.93	78.74	76.1 mm
3.344-0.018	0.083	0.078	3.60	3
84.94-0.46	2.11	1.98	91.44	80
3.834-0.020	0.083	0.083	4.10	
97.38-0.51	2.11	2.11	104.10	101.6 mm
4.084-0.020	0.083	0.083	4.35	
103.73-0.51	2.11	2.11	110.49	108.0 mm
4.334-0.020	0.083	0.083	4.60	4
110.08-0.51	2.11	2.11	116.84	100
5.084-0.020	0.109	0.083	5.35	
129.13-0.51	2.77	2.11	135.89	133.0 mm
5.333-0.020	0.109	0.083	5.60	
135.46-0.51	2.77	2.11	142.24	139.7 mm
5.395-0.022	0.109	0.083	5.66	5
137.03-0.56	2.77	2.11	143.76	125
6.084-0.030	0.109	0.083	6.35	
154.53-0.76	2.77	2.11	161.29	159.0 mm
6.334-0.022	0.109	0.085	6.60	
160.88-0.56	2.77	2.16	167.64	165.1 mm
6.455-0.022	0.109	0.085	6.73	6
163.96-0.56	2.77	2.16	170.94	150
8.331-0.025	0.109	0.092	8.69	
211.61-0.64	2.77	2.34	220.73	216.3 mm
8.441-0.025	0.109	0.092	8.80	8
214.40-0.64	2.77	2.34	223.52	200
10.562-0.027	0.134	0.094	10.92	10
268.27-0.69	3.40	2.39	277.37	250
12.531-0.030	0.156	0.109	12.92	12
318.29-0.76	3.96	2.77	328.17	300
13.781-0.030	0.156	0.109	14.10	14
350.04-0.76	3.96	2.77	358.14	350

Continued on next page

Roll Grooving Dimensions for ANSI B36.10, BS 1387 (M) & AS 1074 (M) Pipe

Basic roll groove dimensions conform to ANSI/AWWA C606-06 Table 5 with slightly adjusted tolerances to incorporate international standards including CSA B242, ISO/FDIS 6152-12, VdS 2100-6en and JPF MP-006.

Nominal Size in / mm	Pipe O.D.			A ±0.030 / ±0.76 in / mm	B ±0.030 / ±0.76 in / mm
	Basic in / mm	Tolerance			
		in / mm	in / mm		
16	16.000	+0.063	-0.031	0.938	0.469
400	406.4	+1.60	-0.79	23.83	11.91
18	18.000	+0.063	-0.031	1.000	0.469
450	457.2	+1.60	-0.79	25.40	11.91
20	20.000	+0.063	-0.031	1.000	0.469
500	508.0	+1.60	-0.79	25.40	11.91
22	22.000	+0.063	-0.031	1.000	0.469
550	558.8	+1.60	-0.79	25.40	11.91
24	24.000	+0.063	-0.031	1.000	0.500
600	609.6	+1.60	-0.79	25.40	12.70

 Refer to page 14 for General notes.

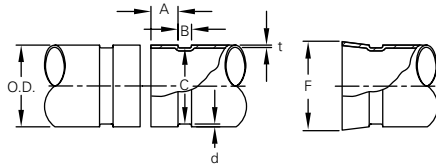

C +0.000 / +0.00 in / mm	t Min. Wall in / mm	d Groove Depth (ref.) in / mm	F Max. Allowed Flare Dia. in / mm	Nominal Size in / mm
15.781-0.030	0.165	0.109	16.10	16
400.84-0.76	4.19	2.77	408.94	400
17.781-0.030	0.165	0.109	18.16	18
451.64-0.76	4.19	2.77	461.26	450
19.781-0.030	0.188	0.109	20.16	20
502.44-0.76	4.78	2.77	512.06	500
21.656-0.030	0.188	0.172	22.20	22
550.06-0.76	4.78	4.37	563.88	550
23.656-0.030	0.218	0.172	24.20	24
600.86-0.76	5.54	4.37	614.68	600

Standard Roll Groove for Large Diameter IPS Pipe ANSI B36.10

Nominal Size in / mm	Pipe O.D.			A ±0.03 / ±0.8 in / mm	B ±0.03 / ±0.8 in / mm
	Basic in / mm	Tolerance			
		in / mm	in / mm		
26	26.0	+0.093	-0.031	1.75	0.625
650	660.4	+2.36	-0.79	44.5	15.9
28	28.0	+0.093	-0.031	1.75	0.625
700	711.2	+2.36	-0.79	44.5	15.9
30	30.0	+0.093	-0.031	1.75	0.625
750	762.0	+2.36	-0.79	44.5	15.9
32	32.0	+0.093	-0.031	1.75	0.625
800	812.8	+2.36	-0.79	44.5	15.9
36	36.0	+0.093	-0.031	1.75	0.625
900	914.4	+2.36	-0.79	44.5	15.9
40	40.0	+0.093	-0.031	2.00	0.625
1000	1016.0	+2.36	-0.79	50.8	15.9
42	42.0	+0.093	-0.031	2.00	0.625
1050	1066.8	+2.36	-0.79	50.8	15.9

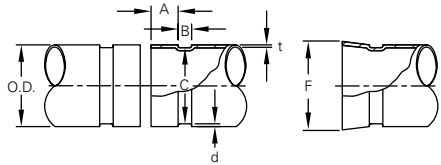

C +0,-0.063 / +0,-1.6 in / mm	d Groove Depth (ref) in / mm	t Min. Wall in / mm	F Max. Allowed Flare Dia. in / mm	Nominal Size in / mm
25.5	0.25	0.25	26.2	26
647.7	6.4	6.4	665.5	650
27.5	0.25	0.25	28.2	28
698.5	6.4	6.4	716.3	700
29.5	0.25	0.25	30.2	30
749.3	6.4	6.4	767.1	750
31.5	0.25	0.25	32.2	32
800.1	6.4	6.4	817.9	800
35.5	0.25	0.25	36.2	36
901.7	6.4	6.4	919.5	900
39.5	0.25	0.25	40.4	40
1003.3	6.4	6.4	1026.2	1000
41.5	0.25	0.25	42.2	42
1054.1	6.4	6.4	1071.9	1050

Standard Roll Groove Specification per ISO/FDIS 6182-12 Table 1

For ISO 4200:1991 Plain-end Steel Tubes, Welded and Seamless (Superseding BS 1387 and DIN 2440 & DIN 2448)

Pipe or tube			C Grooved diameter	
Nominal Size	Outside diameter (O.D.) A		Gasket seat ±0,76	Groove width ±0,76
	Actual Size	Tolerance		
25	33,7	+ 0,41 - 0,68	15,88	7,14
32	42,4	+ 0,50 - 0,60	15,88	7,14
40	48,3	+ 0,44 - 0,52	15,88	7,14
50	60,3	± 0,61	15,88	8,74
65	73,0	± 0,74	15,88	8,74
65	76,1	± 0,76	15,88	8,74
80	88,9	+ 0,89 - 0,79	15,88	8,74
90	101,6	+ 1,02 - 0,79	15,88	8,74
100	108,0	+ 1,07 - 0,79	15,88	8,74
100	114,3	+ 1,14 - 0,79	15,88	8,74
125	133,9	+ 1,32 - 0,79	15,88	8,74
125	139,7	+ 1,40 - 0,79	15,88	8,74
125	141,3	+ 1,42 - 0,79	15,88	8,74
150	159,0	+ 1,60 - 0,79	15,88	8,74
150	165,1	+ 1,60 - 0,79	15,88	8,74
150	168,3	+ 1,60 - 0,79	15,88	8,74
200	219,1	+ 1,60 - 0,79	19,05	11,91
250	277,4	+ 1,60 - 0,79	19,05	11,91
300	328,2	+ 1,60 - 0,79	19,05	11,91

^a See Figure 1 for dimensional diagram.

^b Dimension for reference only, groove diameter is determined by C.

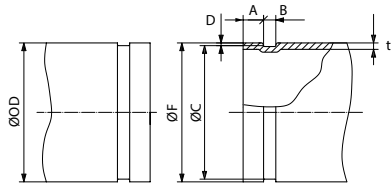

Figure 1- Roll Grooved-End Dimensional Reference Points for Table 1

Dimensions in millimeters

Dimensional specifications ^a				
D ^b	t	F	Wall thickness	Max. Allowed
Actual	Tolerance	Groove	Min. allow.	Flare Dia.
Size		depth		
30,23	$\begin{matrix} 0 \\ -0,38 \end{matrix}$	1,70	1,8	34,5
38,99	$\begin{matrix} 0 \\ -0,38 \end{matrix}$	1,70	1,8	43,3
45,09	$\begin{matrix} 0 \\ -0,38 \end{matrix}$	1,60	1,8	49,4
57,15	$\begin{matrix} 0 \\ -0,38 \end{matrix}$	1,60	1,8	62,2
69,09	$\begin{matrix} 0 \\ -0,46 \end{matrix}$	1,98	2,3	75,2
72,26	$\begin{matrix} 0 \\ -0,46 \end{matrix}$	1,93	2,3	77,7
84,94	$\begin{matrix} 0 \\ -0,46 \end{matrix}$	1,98	2,3	90,6
97,38	$\begin{matrix} 0 \\ -0,51 \end{matrix}$	2,11	2,3	103,4
103,73	$\begin{matrix} 0 \\ -0,51 \end{matrix}$	2,11	2,3	109,7
110,08	$\begin{matrix} 0 \\ -0,51 \end{matrix}$	2,11	2,3	116,2
129,13	$\begin{matrix} 0 \\ -0,51 \end{matrix}$	1,93	2,9	134,9
135,48	$\begin{matrix} 0 \\ -0,51 \end{matrix}$	2,11	2,9	141,7
137,03	$\begin{matrix} 0 \\ -0,56 \end{matrix}$	2,13	2,9	143,5
154,50	$\begin{matrix} 0 \\ -0,56 \end{matrix}$	2,20	2,9	161,0
160,90	$\begin{matrix} 0 \\ -0,56 \end{matrix}$	2,16	2,9	167,1
163,96	$\begin{matrix} 0 \\ -0,56 \end{matrix}$	2,16	2,9	170,7
214,40	$\begin{matrix} 0 \\ -0,64 \end{matrix}$	2,34	2,9	221,5
268,28	$\begin{matrix} 0 \\ -0,69 \end{matrix}$	2,39	3,6	275,4
318,29	$\begin{matrix} 0 \\ -0,76 \end{matrix}$	2,77	4,0	326,2

Standard Roll Groove Specification

KS D3507 & JIS G3452 Carbon Steel Pipe

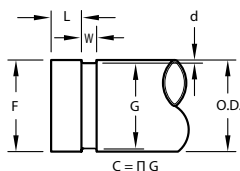

Nominal size		Gasket Pipe O.D. mm	L Groove Seat +0.76* mm	W Groove Width +0.76* mm	G Groove		C Groove Max. Circumference (ref)		d Depth Flare Dia. mm	F Allowed mm
A mm	B in				Basic +0.00* mm	Tolerance mm	mm	mm		
25A	1	34.0	16.0	7.1	30.4	-0.38	95.5	0 / -3.1	1.80	35.5
32A	1¼	42.7	16.0	7.1	39.1	-0.38	122.8	0 / -3.1	1.80	44.2
40A	1½	48.6	16.0	7.1	45.0	-0.38	141.4	0 / -3.1	1.80	50.1
50A	2	60.5	16.0	8.7	56.9	-0.38	178.8	0 / -3.1	1.80	62.0
65A	2½	76.3	16.0	8.7	72.2	-0.46	226.8	0 / -3.1	2.05	77.8
80A	3	89.1	16.0	8.7	84.9	-0.46	266.7	0 / -3.1	2.10	90.6
100A	4	114.3	16.0	8.7	110.1	-0.51	345.9	0 / -3.1	2.10	116.8
125A	5	139.8	16.0	8.7	135.5	-0.56	425.7	0 / 3.1	2.15	142.3
150A	6	165.2	16.0	8.7	160.8	-0.56	505.2	0 / -3.1	2.20	167.7
200A	8	216.3	19.0	11.9	211.6	-0.64	664.8	0 / -3.1	2.35	219.8
250A	10	267.4	19.0	11.9	262.6	-0.69	825.0	0 / -3.1	2.40	270.9
300A	12	318.5	19.0	11.9	312.9	-0.76	983.0	0 / -3.1	2.80	322.0

Groove Diameter: Groove Diameters "G" are only applicable to pipe sizes 150A or smaller. Grooves for 200A thru 300A are to be determined by the groove circumference.

Groove Depth: The "d" is for reference use only.

Flare Diameter: The maximum flare diameters (F) are target values.

* The tolerance for the JIS & KS pipe has a little difference.

 Refer to page 14 for General notes.

Standard Roll Groove for U.S. Standard Copper Tubing

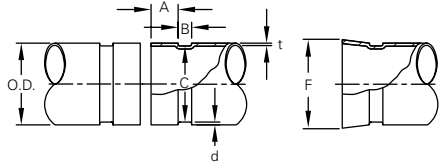

Nominal Size	Pipe O.D. Basic Size	A Gasket Seat ± 0.03 ± 0.79	B Groove Width ± 0.03 ± 0.79	C Groove Dia. $+0/-0.02$ $+0/-0.51$	d Groove Depth (ref.)	t Min. Wall	F Max. Allowed Flare Dia.
							in / mm
2	2.125	0.610	0.300	2.029	0.048	0.064	2.220
50	54.0	15.5	7.6	51.5	1.2	1.6	56.4
2½	2.625	0.610	0.300	2.525	0.050	0.065	2.720
65	66.7	15.5	7.6	64.1	1.3	1.7	69.1
3	3.125	0.610	0.300	3.025	0.050	DWV	3.220
80	79.4	15.5	7.6	76.8	1.3		81.8
4	4.125	0.610	0.300	4.019	0.053	DWV	4.220
100	104.8	15.5	7.6	102.1	1.4	DWV	107.2
5	5.125	0.610	0.300	4.999	0.053	DWV	5.220
125	130.2	15.5	7.6	127.0	1.4	DWV	132.6
6	6.125	0.610	0.300	5.999	0.063	DWV	6.220
150	155.6	15.5	7.6	152.3	1.6	DWV	158.0

Standard Roll Groove for BS EN 1057 Copper Tubing

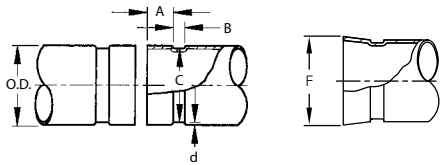

Nominal Size	Pipe O.D. Gasket		A Gasket Seat $+0.8/-0$ mm	B Groove Width $+0.8/-0$ mm	C Groove Dia. $+0/-0.5$ mm	d Max. Depth (ref.) mm	F Allowed Flare Dia. mm
	Min. mm	Max. mm					
54.0	53.99	54.07	15.87	7.6	51.53	1.25	56.39
66.7	66.60	66.75	15.87	7.6	64.14	1.27	69.09
76.1	76.15	76.30	15.87	7.6	73.53	1.35	78.61
108.0	108.00	108.25	15.87	7.6	104.93	1.60	110.54
133.0	133.25	133.50	15.87	7.6	129.67	1.85	135.79
159.0	159.25	159.50	15.87	7.6	155.68	1.85	161.80

General Notes for Cut Groove Dimensions

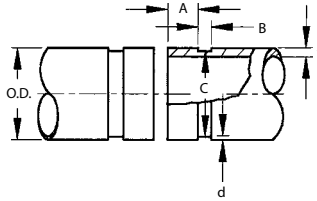

Standard Cut Groove

Nominal Size: Shurjoint couplings and fittings are identified by the nominal IPS pipe size in inches or nominal outside diameter of pipe in millimeters.

O.D.: Pipe ends must be square cut. The Maximum allowable tolerances from square of end is 0.03" (0.8 mm) for sizes up to 3½", 0.045" (1.2 mm) for 4" thru 6" and 0.060" (1.6 mm) for sizes 8" and above.

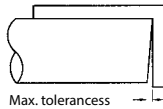

Gasket Seating Surface ("A" Dimension): The exterior surface of the gasket seating area shall be free from any indentations, projections, roll marks or other harmful surface defects such as loose paint, scale, dirt, chips, grease and rust.

Groove Width ("B" Dimension): The groove width is to be measured between vertical flanks of the groove side walls.

Groove Diameter ("C" Dimension): The groove diameters are average values. The groove must be of uniform depth around the entire pipe circumference.

Minimum Wall Thickness ("t" Dimension): The "t" is the minimum allowable wall thickness that may be cut-grooved.

Groove Depth ("d" Dimension): The values listed in the Groove Specification tables

are for reference only and a slightly deeper groove may be acceptable. However, a shallower groove is never acceptable as it may lead to joint failure.

Cut Grooving Dimensions

for IPS / BS / AS / ISO / JIS / KS Pipe

Nominal Size in / mm	Pipe O.D.			A ±0.031 ±0.79
	Basic in / mm	Tolerance		
		in / mm	in / mm	
¾	1.050	+0.010	-0.010	0.625
20	26.7	+0.25	-0.25	15.88
1	1.315	+0.028	-0.015	0.625
25	33.4	+0.71	-0.38	15.88
1¼	1.660	+0.029	-0.016	0.625
32	42.2	+0.74	-0.41	15.88
1½	1.900	+0.019	-0.019	0.625
40	48.3	+0.48	-0.48	15.88
2	2.375	+0.024	-0.024	0.625
50	60.3	+0.61	-0.61	15.88
2½	2.875	+0.029	-0.029	0.625
65	73.0	+0.74	-0.74	15.88
76.1 mm	3.000	+0.030	-0.030	0.625
	76.1	+0.76	-0.76	15.88
3	3.500	+0.035	-0.031	0.625
80	88.9	+0.89	-0.79	15.88
101.6 mm	4.000	+0.040	-0.031	0.625
	101.6	+1.02	-0.79	15.88
108.0 mm	4.250	+0.042	-0.031	0.625
	108.0	+1.07	-0.79	15.88
4	4.500	+0.045	-0.031	0.625
100	114.3	+1.14	-0.79	15.88
133.0 mm	5.250	+0.052	-0.031	0.625
	133.0	+1.32	-0.79	15.88
139.7 mm	5.500	+0.056	-0.031	0.625
	139.7	+1.42	-0.79	15.88
5	5.563	+0.056	-0.031	0.625
125	141.3	+1.42	-0.79	15.88
159.0 mm	6.250	+0.063	-0.031	0.625
	159.0	+1.60	-0.79	15.88
165.1 mm	6.500	+0.063	-0.031	0.625
	165.1	+1.60	-0.79	15.88
6	6.625	+0.063	-0.031	0.625
150	168.3	+1.60	-0.79	15.88
8	8.625	+0.063	-0.031	0.750
200	219.1	+1.60	-0.79	19.05
10	10.750	+0.063	-0.031	0.750
250	273.0	+1.60	-0.79	19.05
12	12.750	+0.063	-0.031	0.750
300	323.9	+1.60	-0.79	19.05

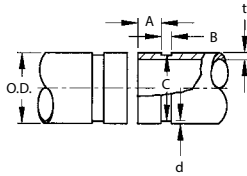

B ±0.031 ±0.79	C ±0.031 ±0.79	t Min. Wall in / mm	d Groove Depth (ref.) in / mm	Nominal Size in / mm
0.313	0.938-0.015	0.113	0.056	¾
7.95	23.83-0.38	2.87	1.42	20
0.313	1.190-0.015	0.133	0.063	1
7.95	30.23-0.38	3.38	1.60	25
0.313	1.535-0.015	0.140	0.063	1¼
7.95	38.99-0.38	3.56	1.60	32
0.313	1.775-0.015	0.145	0.063	1½
7.95	45.09-0.38	3.68	1.60	40
0.313	2.250-0.015	0.154	0.063	2
7.95	57.15-0.38	3.91	1.60	50
0.313	2.720-0.018	0.188	0.078	2½
7.95	69.09-0.46	4.78	1.98	65
0.313	2.845-0.018	0.188	0.076	76.1 mm
7.95	72.26-0.46	4.78	1.93	
0.313	3.344-0.018	0.188	0.078	3
7.95	84.94-0.46	4.78	1.98	80
0.313	3.834-0.020	0.188	0.078	101.6 mm
7.95	97.38-0.51	4.78	1.98	
0.375	4.084-0.020	0.203	0.083	108.0 mm
9.53	103.73-0.51	5.16	2.11	4
0.375	4.334-0.020	0.203	0.083	100
9.53	110.08-0.51	5.16	2.11	133.0 mm
0.375	5.084-0.020	0.203	0.083	139.7 mm
9.53	129.13-0.51	5.16	2.11	
0.375	5.334-0.022	0.203	0.083	5
9.53	135.48-0.56	5.16	2.11	125
0.375	5.395-0.022	0.203	0.083	159.0 mm
9.53	137.03-0.56	5.16	2.11	
0.375	6.084-0.022	0.219	0.083	165.1 mm
9.53	154.53-0.56	5.56	2.11	
0.375	6.330-0.022	0.203	0.085	165.1 mm
9.53	160.78-0.56	5.16	2.16	
0.375	6.455-0.022	0.219	0.085	6
9.53	163.96-0.56	5.56	2.16	150
0.438	8.441-0.025	0.238	0.092	8
11.13	214.40-0.64	6.05	2.34	200
0.500	10.562-0.027	0.250	0.094	10
12.70	268.27-0.69	6.35	2.39	250
0.500	12.531-0.030	0.279	0.109	12
12.70	318.29-0.76	7.09	2.77	300

Continued on next page

Cut Grooving Dimensions

for IPS / BS / AS / ISO / JIS / KS Pipe

Nominal Size in / mm	Pipe O.D.			A ±0.031 ±0.79
	Basic in / mm	Tolerance		
		in / mm	in / mm	
200 JIS	8.516	+0.063	-0.031	0.750
	216.3	+1.60	-0.79	19.05
250 JIS	10.528	+0.063	-0.031	0.750
	267.4	+1.60	-0.79	19.05
300 JIS	12.539	+0.063	-0.031	0.750
	318.5	+1.60	-0.79	19.05
14	14.000	+0.063	-0.031	0.938
350	355.6	+1.60	-0.79	23.83
16	16.000	+0.063	-0.031	0.938
400	406.4	+1.60	-0.79	23.83
18	18.000	+0.063	-0.031	1.000
450	457.2	+1.60	-0.79	25.40
20	20.000	+0.063	-0.031	1.000
500	508.0	+1.60	-0.79	25.40
22	22.000	+0.063	-0.031	1.000
550	558.8	+1.60	-0.79	25.40
24	24.000	+0.063	-0.031	1.000
600	609.6	+1.60	-0.79	25.40

Refer to page 26 for General notes.

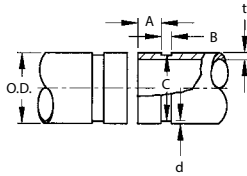

B ±0.031 ±0.79	C ±0.031 ±0.79	t Min. Wall in / mm	d Groove Depth (ref.) in / mm	Nominal Size in / mm
0.438 11.13	8.331-0.022 211.61-0.56	0.238 6.05	0.092 2.34	200 JIS
0.500 12.70	10.339-0.027 262.60-0.69	0.250 6.35	0.094 2.39	250 JIS
0.500 12.70	12.319-0.030 312.90-0.76	0.279 7.09	0.109 2.77	300 JIS
0.500 12.70	13.781-0.030 350.04-0.76	0.281 7.14	0.109 2.77	14 350
0.500 12.70	15.781-0.030 400.84-0.76	0.312 7.92	0.109 2.77	16 400
0.500 12.70	17.781-0.030 451.64-0.76	0.312 7.92	0.109 2.77	18 450
0.500 12.70	19.781-0.030 502.44-0.76	0.312 7.92	0.109 2.77	20 500
0.563 14.30	21.656-0.030 550.06-0.76	0.375 9.53	0.172 4.37	22 550
0.562 14.27	23.656-0.030 600.86-0.76	0.375 9.53	0.172 4.37	24 600

"EP" End Protection Cut Groove Specification for XH-70EP Couplings (IPS sizes)

This standard is for high pressure rigid systems used with Shurjoint XH-70EP couplings.

Caution: Groove dimensions and tolerances are different from that of standard cut-grooves shown on page 28. Special attention is required when processing cut-grooves to this standard.

Nominal Size in / mm	Pipe O.D.			A	
	Basic in / mm	Tolerance		Gasket Seat	
		+	-	Basic in / mm	Tol. ± in / mm
	in / mm	in / mm	in / mm	in / mm	in / mm
2	2.375	+0.024	-0.024	0.562	±0.010
50	60.3	+0.61	-0.61	14.27	±0.25
2½	2.875	+0.029	-0.029	0.562	±0.010
65	73.0	+0.74	-0.74	14.27	±0.25
3	3.500	+0.035	-0.031	0.562	±0.010
80	88.9	+0.89	-0.79	14.27	±0.25
4	4.500	+0.045	-0.031	0.605	±0.015
100	114.3	+1.14	-0.79	15.37	±0.38
6	6.625	+0.063	-0.031	0.605	±0.015
150	168.3	+1.60	-0.79	15.37	±0.38
8	8.625	+0.063	-0.031	0.714	±0.015
200	219.1	+1.60	-0.79	18.14	±0.38
10	10.750	+0.063	-0.031	0.714	±0.015
250	273.0	+1.60	-0.79	18.14	±0.38
12	12.750	+0.063	-0.031	0.714	±0.015
300	323.9	+1.60	-0.79	18.14	±0.38

 Refer to page 26 for general notes.

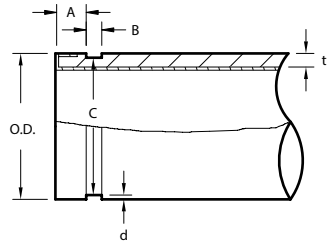

B		C		d	t	Size
Gasket Width		Groove dia.				
Basic in / mm	Tol. +0.010 / +0.25 in / mm	Basic in / mm	Tol. +0 / +0 in / mm	in / mm	in / mm	in / mm
0.255	-0.005	2.250	-0.015	0.063	0.154	2
6.48	-0.13	57.15	-0.38	1.60	3.91	50
0.255	-0.005	2.720	-0.018	0.078	0.188	2½
6.48	-0.13	69.09	-0.46	1.98	4.78	65
0.255	-0.005	3.344	-0.018	0.078	0.188	3
6.48	-0.13	84.94	-0.46	1.98	4.78	80
0.305	-0.005	4.334	-0.020	0.083	0.203	4
7.75	-0.13	110.08	-0.51	2.11	5.16	100
0.305	-0.005	6.455	-0.022	0.085	0.219	6
7.75	-0.13	163.96	-0.56	2.16	5.56	150
0.400	-0.010	8.441	-0.025	0.092	0.238	8
10.16	-0.25	214.40	-0.64	2.34	6.05	200
0.400	-0.010	10.562	-0.027	0.094	0.250	10
10.16	-0.25	268.28	-0.69	2.39	6.35	250
0.400	-0.010	12.531	-0.030	0.109	0.279	12
10.16	-0.25	318.29	-0.76	2.77	7.09	300

Radius Cut Grooving Dimensions - Ductile Iron Pipe

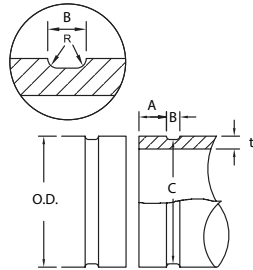

AWWA Ductile Iron Pipe

Nominal Size in / mm	Pipe O.D.			A Gasket Seat	
	Basic in / mm	Tolerance		Rigid	Flex.
		+	-	+0 / -0.02 +0 / -0.51	+0.016 / -0.047 +0.41 / -1.19
in / mm	in / mm	in / mm	in / mm	in / mm	in / mm
3	3.96	+0.045	-0.045	0.840	0.750
80	100.6	+1.14	-1.14	21.34	19.05
4	4.80	+0.045	-0.045	0.840	0.750
100	121.9	+1.14	-1.14	21.34	19.05
6	6.90	+0.060	-0.060	0.840	0.750
150	175.3	+1.52	-1.52	21.34	19.05
8	9.05	+0.060	-0.060	0.840	0.875
200	229.9	+1.52	-1.52	21.34	22.83
10	11.10	+0.060	-0.060	1.015	0.938
250	281.9	+1.52	-1.52	25.78	23.83
12	13.20	+0.060	-0.060	1.015	0.938
300	335.3	+1.52	-1.52	25.78	23.83
14	15.30	+0.050	-0.080	1.015	0.938
350	388.6	+1.27	-2.03	25.78	23.83
16	17.40	+0.050	-0.080	1.340	1.188
400	442.0	+1.27	-2.03	34.04	30.18
18	19.50	+0.050	-0.080	1.340	1.188
450	495.3	+1.27	-2.03	34.04	30.18
20	21.60	+0.050	-0.080	1.340	1.188
500	548.6	+1.27	-2.03	34.04	30.18
24	25.80	+0.050	-0.080	1.340	1.188
600	655.3	+1.27	-2.03	34.04	30.18

Gasket Seating Surface (A)

The same coupling can be used either as a rigid joint or a flexible joint depending on the groove. Gasket seat "A Rigid" is for rigid joints and Gasket seat "A Flex." for flexible joints.

The gasket seating surface shall be free from deep scores, marks, or ridges indentations, projections, and cracks that could prevent a positive seal. The peened surfaces of Ductile Iron Pipe are not always consistent and in some cases, may require rework to provide a leak free sealing surface. (see CSA B242 5.9 or AWWA C606).

Groove Diameter (C)

The 'C' diameters are average values. The groove must be of uniform depth around the entire pipe circumference.

Radius (R)

The groove must be cut with a radius "R" at the corners of the groove to reduce stress concentration.

Minimum Wall Thickness (t)

"t" is the minimum allowable wall thickness that may be cut-grooved; tolerances are to conform to ANSI /AWWA C151/A21.51.

B Gasket Width +0.031 / -0.016 +0.79 / -0.41 in / mm	C Groove Dia.		R Radius in / mm	t Min. Allow Wall Thickness in / mm	Nominal Size in / mm
	Basic in / mm	Tol. +0 +0 in / mm			
0.375	3.723	-0.020	0.120	0.31	3
9.53	94.56	-0.51	3.05	7.9	80
0.375	4.563	-0.020	0.120	0.32	4
9.53	115.90	-0.51	3.05	8.1	100
0.375	6.656	-0.020	0.120	0.34	6
9.53	169.06	-0.51	3.05	8.6	150
0.500	8.781	-0.025	0.145	0.36	8
12.70	223.04	-0.64	3.68	9.1	200
0.500	10.813	-0.025	0.145	0.38	10
12.70	274.65	-0.64	3.68	9.7	250
0.500	12.906	-0.030	0.145	0.40	12
12.70	327.81	-0.76	3.68	10.2	300
0.625	14.969	-0.030	0.165	0.42	14
15.88	380.21	-0.76	4.19	10.7	350
0.625	17.063	-0.030	0.165	0.43	16
15.88	433.40	-0.76	4.19	10.9	400
0.625	19.125	-0.030	0.185	0.44	18
15.88	485.78	-0.76	4.70	11.2	450
0.625	21.219	-0.030	0.185	0.45	20
15.88	538.96	-0.76	4.70	11.4	500
0.625	25.046	-0.030	0.185	0.47	24
15.88	645.31	-0.76	4.70	11.9	600

Bolts & Nuts

Carbon Steel Bolts & Nuts

Shurjoint products utilize oval neck track bolts conforming to ASTM A449 and ASTM A183 Gr. 2 and heavy duty hex nuts to ASTM A563 Gr. B, available with UNC threads or ISO metric threads. The UNC track bolts and nuts are supplied electro zinc plated in a silver chromate color and ISO metric bolts and nuts in a gold chromate color. Hot-dip galvanized bolts and nuts are also available upon request.

Recommended Bolt Torque

Always use factory supplied bolts and nuts for assembly of Shurjoint couplings. Shown below are the general recommended torque ranges for common sizes of carbon steel bolts. Never exceed the recommended torque range as excessive torque can lead to joint failure, personal injury and/or property damage. Always depressurize and drain the piping system before attempting disassembly, adjustment or removal of any piping component. Follow installation instructions for proper assembly of all Shurjoint components. For questions contact Shurjoint.

Bolt Size		Torque Range	
mm	inch	Lbs-Ft	Nm
M8	5/16" - 18	15-25	20-34
M10	3/8" - 16	30-40	40-55
M12	1/2" - 13	90-105	120-140
M16	5/8" - 11	100-130	135-175
M20	3/4" - 10	150-200	200-270
M22	7/8" - 9	180-220	240-300
M24	1" - 8	200-225	270-305
M29	1 1/8" - 7	250-300	340-400
M32	1 1/4" - 7	375-500	510-680

Helpful Information to Ensure Proper Assembly

Some couplings and components require the housing bolt pads to make metal-to-metal contact for proper assembly, while others require a specific bolt torque while maintaining equal bolt pad gaps. The icons and information below will help to identify those items to ensure proper assembly. Read and follow all installation instructions for the component being installed.



Metal-to-metal contact: Tighten bolts and nuts until bolt pads make metal-to-metal contact. After metal-to-metal contact is achieved, tighten nuts by another one quarter or one half turn to make sure the bolts and nuts are snug and secure. No torque wrench is required. Never exceed torque stated in the table on page 36. Excessive torque may lead to bolt or joint failure.

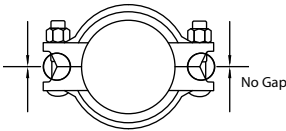

Metal-to-metal contact

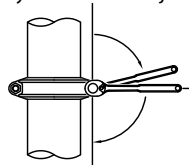

After metal-to-metal, further tighten one quarter or half turn

If bolt pad gaps are evident after installation, disassemble and reinstall the coupling after checking the following:

- The coupling, pipe and/or fitting being connected are the correct size.
- The coupling keys are fully engaged in the pipe and/or component grooves.
- The gasket is not being pinched.
- The grooves conform to the applicable groove dimension specifications.
- The pipe end flare is within the specification tolerance.



Torque required! Bolts and nuts must always be tightened to the required torque by using a torque wrench. Normally there will be some gaps seen between the bolt pads after the bolts and nuts are fully tightened. Models that require torque tightening include 2" through 4" of Model XH-1000, all sizes of Models XH-70EP, SS-7X and 79 couplings.



Always use a torque wrench

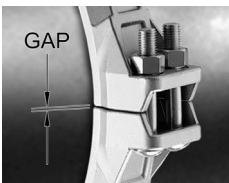

#SS-7X 10" ~ 24"

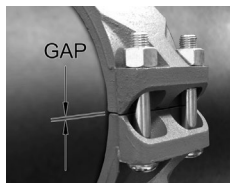

#79 2" ~ 20"

Rubber Gaskets

Grades and Recommended Services

Shurjoint utilizes the finest gasket materials available in our products. Over the past 50 years great advances have been made in synthetic elastomer technologies, allowing us to offer a full range of synthetic rubber gasket materials for a wide variety of piping applications. Shurjoint gaskets are engineered and designed to meet and exceed standards such as ASTM D2000, AWWA C606, NSF 61 and IAPMO. Our own stringent internal laboratory testing confirms this. Our continual research, development and testing are designed to advance the elastomer field and to develop new and better solutions for our ever changing industry.



Chemical resistance is primarily determined by the grade and/or the compound of the gasket. The color coding identifies the gasket grade and/or compound. Always verify that the gasket selected is correct for the intended service.

Service temperature is controlled by factors including the gasket compound, fluid medium (air, water, oils, etc.), and continuity (continuous or intermittent) of service. Under no circumstances should gaskets be exposed to temperatures above or below their individual ratings. For additional information or specific applications contact Shurjoint for recommendations.

Gasket Selection Guide

Proper gasket selection is essential for the optimum performance of Shurjoint grooved couplings, flange adapters and mechanical tees.

1. Gasket styles: Shurjoint grooved couplings utilize several different gasket styles, standard, GapSeal, EP (End Protection) and FF (Fast Fit). GapSeal gaskets are compatible with standard gaskets and they are interchangeable with each other. Other special styles are not compatible with standard or GapSeal gaskets. Always use the correct gasket style for the coupling model you selected.

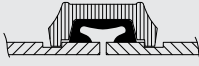

Standard



Reducing



GapSeal



Reducing
(2" x 1 1/2", 2 1/2" x 2", 3" x 2 1/2")



End Protection

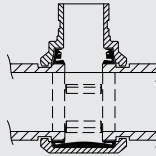

Outlet Coupling



FastFit®



Flange Adapter

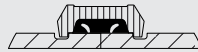

AWWA Ductile Iron Pipe

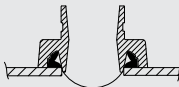

Mechanical Tee

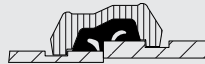

IPS to AWWA



Saddle-Let

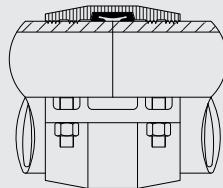

HDPE Pipe



Wildcat

2. Vacuum service: Shurjoint standard gaskets are designed to seal well under vacuum conditions up to 10 inHg (absolute)/254 mmHg (absolute) which may occur when a system is drained. For continuous services greater than 10 inHg (absolute)/254 mmHg (absolute), the use of GapSeal gaskets or EP (End Protection) gaskets in combination with rigid style couplings is recommended. Contact Shurjoint for specific recommendations.

3. Dry pipe and freezer services: Shurjoint recommends the use of GapSeal Grade "E" gaskets for dry pipe fire protection systems and freezer applications. The GapSeal gasket closes off the gap between the pipes or gasket cavity. This will prevent any remaining liquid from entering the cavities and freezing when the temperature drops. Rigid couplings are preferred for dry pipe, freezer and vacuum applications. Reducing couplings are not recommended for these applications.

NOTE: Do not use the Shurjoint standard Lubricant for dry pipe and freezer systems, instead use Shurjoint EHC silicone Lubricant designed for extreme hot and cold temperatures.

4. ANSI/NSF 61 Standard: ANSI/NSF 61 classified gaskets are good for potable water services. The classification categories are 'cold' which is limited to +86°F (+30°C) (or maximum ambient distribution temperatures of unheated water) maximum and 'hot' which is limited to +180°F (+82°C) (or scalding temperatures of hot domestic water).

5. Lubricant: Shurjoint Lubricant is recommended for proper gasket installation to prevent the gasket from being pinched. Apply a thin coat to the gasket exterior, gasket lips and/or housing interiors. Shurjoint Lubricant is available in one pound (450 grams) and one quart (2 pounds or 900 grams) containers. Certified to ANSI/NSF 61. Shurjoint EHC silicone lubricant is also available upon request.



Gasket Grade Index

Compound	Grade	Color Code	General Service Recommendations	Maximum Temp. Range
EPDM	E	Green Stripe	Good for cold & hot water up to +230°F (+110°C). Also good for services for water with acid, water with chlorine, deionized water, seawater and waste water, dilute acids, oil-free air and many chemicals. Not recommended for petroleum oils, mineral oils, solvents and aromatic hydrocarbons.	-30°F (-34°C) to +230°F (+110°C)
Nitrile	T	Orange Stripe	Good for petroleum oils, mineral oils, vegetable oils, non-aromatic hydrocarbons, many acids and water +150°F (+65°C).	-20°F (-29°C) to +180°F (+82°C)
EPDM	EHM	Green + Red Stripe	Good for cold & hot water up to +250°F (+121°C). Also good for services for water with acid, water with chlorine, deionized water, seawater and waste water, dilute acids, oil-free air and many chemicals. Not recommended for petroleum oils, mineral oils, solvents and aromatic hydrocarbons.	-30°F (-34°C) to +250°F (+121°C)
EPDM	E-pw	Double Green Stripe	Specially compounded for cold +86°F (+30°C) and hot +180°F (+82°C) potable water services. The compound is UL classified per ANSI/NSF 61.	≤+180°F (+82°C)
EPDM	Lube-E	Green + Violet Stripe	A pre-lubricated gasket intended primarily for the fire protection industry.	-30°F (-34°C) to +230°F (+110°C)
White Nitrile	A	White Gasket	Good for oily and greasy food products and processing, as well as pharmaceutical and cosmetics manufacturing. Compounded from FDA approved ingredients (CFR Title 21 Part 177.2600).	+20°F (-7°C) to +180°F (+82°C)
Silicone	L	Red Gasket	Good for dry, hot air without hydrocarbons and some high temperature chemical services. May also be used for fire protection dry systems.	-30°F (-34°C) to +350°F (+177°C)
Neoprene	V	Yellow Stripe	Good for hot lubricating oils and certain chemicals.	-30°F (-34°C) to +180°F (+82°C)
Fluoro-elastomer (Viton)	O	Blue Stripe	Good for many oxidizing acids, petroleum oils, halogenated hydrocarbons, lubricants, hydraulic fluids, organic liquids and air with hydrocarbons to +300°F (+149°C).	+20°F (-7°C) to +300°F (+149°C)
Epichlorohydrin	M2	White Stripe	Good for aromatic fuels at low temperatures and also for ambient temperature water.	-40°F (-40°C) to +160°F (+71°C)

Special Gaskets for AWWA Ductile Iron Pipe

Compound	Grade	Color Code	General Service Recommendations	Maximum Temp. Range
Nitrile	S	Red Stripe	Specially compounded for use with AWWA ductile iron pipe and used for petroleum products, mineral oils, vegetable oils and air with oil vapors.	-20°F (-29°C) to +180°F (+82°C)
Halogenated Butyl	M	Brown Stripe	Good for water services, mild dilute acids, oil-free air and many chemicals. The compound is UL classified per ANSI/NSF 61.(AWWA ductile iron pipe use)	-20°F (-29°C) to +200°F (+93°C)

Please note that EPDM grade "EH" gaskets can be used for all applications and services that EPDM grade "E" gaskets are suitable for.

WARNING

EPDM gaskets for water services are not recommended for steam services. In many systems additives are introduced for maintenance and preventive reasons. Compatibility of gasket material and these additives should be considered in your gasket selection.

Failure to select the proper gasket and compound may result in joint leakage or failure resulting in personal injury and/or property damage. Gaskets should never be exposed to temperatures outside their ratings.

General Gasket Service Recommendations

The following are general service recommendations only and the information provided is based on the best information available from various resources including elastomer manufacturers, leading rubber molders, industry publications and our own laboratory testing and field experience. The information contained herein shall be considered for evaluation purposes and not as a guarantee. When and wherever possible, gasket materials should be tested with simulated service conditions to determine suitability for the intended service application. Unless otherwise noted, the recommendations are based on ambient temperatures. These recommendations do not apply to rubber lined products or rubber sealed valves. If more than one gasket grade is listed the preferred grade is listed first for general services. For chemicals not listed, a combination of chemicals listed or not, service temperatures not listed or borderline services, contact a Shurjoint Engineering Representative for a recommendation.

Note: NR = Not Recommended

CHEMICAL SERVICES	
Chemical Composition	Gasket Grade
Acetaldehyde	E
Acetamide	T
Acetic Acid up to 10% 100°C (38°C)	E/L
Acetic Acid up to 10-50% 100°C (38°C)	L
Acetic Acid, Glacial 100°C (38°C)	L
Acetic Anhydride	E
Acetone	E
Acetonitrile	T
Acetophenone	E
Acetylene	E/T
Acrylic Resin	V
Acrylonitrile	NR
Adipic Acid	T
Air, oil free	E
Air with vaped oil	T
Alkalis	E
Allyl Alcohol to 96%	E
Allyl Chloride	NR
Alum Sulfuric Acid	O
Alums	E/T
Aluminum Chloride	E/T
Aluminum Fluoride	E/T/O

CHEMICAL SERVICES	
Chemical Composition	Gasket Grade
Aluminum Hydroxide	E/O
Aluminum Nitrate	E/T/V
Aluminum Oxychloride	T
Aluminum Phosphate	E
Aluminum Salts	E/T
Aluminum Sulfate	E/T
Alums	E/T
Ammonia Anhydrous (Pure Ammonia)	NR
Ammonia Gas, Cold	E
Ammonia, Aqua, 10-25%	E
Ammonia, Liquid	E
Ammonium Alum	V
Ammonium Bifluoride	T
Ammonium Carbonate	E
Ammonium Chloride	E/T
Ammonium Fluoride	E
Ammonium Hydroxide	E
Ammonium Metaphosphate	E
Ammonium Nitrate	E/T
Ammonium Nitrite	E
Ammonium Persulfate, to 10%	E
Ammonium Phosphate	T

CHEMICAL SERVICES	
Chemical Composition	Gasket Grade
Ammonium Sulfamate	T
Ammonium Sulfate	E/T
Ammonium Sulfide	E
Ammonium Thiocyanate	E
Amyl Acetate	E
Amyl Alcohol	E
Amyl Borate	V
Amyl Chloride	NR
Amyl Chloronaphthalene	T
Anderol	O
Aniline	E
Aniline Dyes	E
Aniline Hydrochloride	E
Aniline Oil	E
Animal Fats	A
Anthraquinone	NR
Anthraquinone Sulfonic Acid	NR
Antimony Chloride	E
Antimony Trichloride	E
Argon Gas	E/O
Aroclor(S)	O
Arsenic Acid, to 75%	E/T/O
Arylsulfonic Acid	NR
ASTM #1, 2 & 3 Oil	T
Barium Carbonate	E
Barium Chloride	E/T
Barium Hydroxide	E/T
Barium Nitrate	V
Barium Sulfide	T
Beer	A
Beet Sugar liquors	A
Benzaldehyde	E
Benzene	O
Benzine (see Petroleum Ether)	O
Benzoic Acid	E
Benzol	O
Benzyl Alcohol	E
Benzyl Benzoate	E
Benzyl Chloride	E

CHEMICAL SERVICES	
Chemical Composition	Gasket Grade
Black Sulfate Liquor	T
Blast Furnace Gas	T
Bleach, 12% Active Cl ₂	E
Borax Solutions	E
Bordeaux Mixture	E
Boric Acid	E/T
Bromine	O
Bromine Water	V
Butane Gas	T
Bromotoluene	NR
Butanol (see Butyl Alcohol)	E/T
Butter	A
Butyl Acetate Ricinoleate	E/T
Butyl Alcohol	E/T
Butyl "Cellosolve Adipate"	E/T
Butyl Phenol	E
Butyl Stearate	T/O
Butylene	T/O
Butylene Glycol	E
Butyne Diol	NR
Calcium Acetate	T
Calcium Bisulphite	T/O
Calcium Carbonate	E/T
Calcium Chlorate	E/T
Calcium Chloride	E/T
Calcium Hydroxide (Lime)	E/T
Calcium Hypochlorite	E
Calcium Hypochloride	E
Calcium Nitrate	E/T/V
Calcium Sulfate	E/T
Calcium Sulfide	E/T
Caliche Liquors	T
Cane Sugar Liquors	A
Carbitol	E/T
Carbonic Acid, Phenol	O
Carbon Bisulphide	O
Carbon Dioxide, Dry	E/T
Carbon Dioxide, Wet	E/T
Carbon Disulphide	O

CHEMICAL SERVICES	
Chemical Composition	Gasket Grade
Carbon Monoxide	E
Carbon Tetrachloride	O
Carbonic Acid, Dry	O
Caster Oil	T/A
Caustic Potash	E/T
Cellosolve	E/V
Cellosolve Acetate	E
Cellosolve (Alcohol Ether)	E
Cellulose Acetate	E
Cellulube 220 (Tri-Aryl-Phosphate)	E
Cellulube Hydraulic Fluids	E
China Wood Oil, Tung Oil	T
Chloric Acid to 20%	E
Chlorine, Dry	O
Chlorine, Water 4000 PPM (max.)	E
Chlorinated Paraffin (Chlorocosane)	T
Chloroacetic Acid	E
Chloroacetone	E
Chlorobenzene	O
Chloralhydrate	NR
Chlorobromomethane	NR
Chloroform	O
Chlorosulphonic Acid	NR
Chrome Alum	E/T
Chromic Acid, to 10%	O
Chromic Acid, to 25%	O
Chrome Plating Solutions	O
Citric Acid, Saturated	E
Citric Acid	E/T
Coconut Oil	A
Cod Liver Oil	A
Coke Oven Gas	T/O
Copper Carbonate	E/T
Copper Chloride	E/T
Copper Cyanide	E/T
Copper Fluoride	E
Copper Nitrate	E/T

CHEMICAL SERVICES	
Chemical Composition	Gasket Grade
Copper Sulfate	E/T
Corn Oil	A
Cotton Seed Oil	A
Creosol, Cresylic Acid	O
Creosote, Coal Tar	T/O
Creosote, Wood	T/O
Cupric Fluoride	E/T
Cupric Sulfate	E/T
Cyclohexane (Alicyclic Hydrocarbon)	O
Cyclohexanol	V/O
Cyclohexanone	E
Deionized Water	E
Dextrin	T
Diacetone Alcohol	V
Dibutyl Phthalate	E
Dichloro Difloro Methane	T
Dicyclohexylamine	T
Diesel Oil	T
Diethyl Ether	T
Diethyl Sebacate	E
Diethylamine	T
Diethylene Glycol	E/T
Digester Gas	T
Dimethylamine	T
Diocetyl Phthalate	E
Dioxane	E
Dipentene(Terpene-Hydrocarbon)	T
Dipropylene Glycol	T
Dowtherm A	O
Dowtherm E	O
Dowtherm SR-1	T/E
Ethane	E
Ethanolamine	E
Ethers	NR
Ethyl Acetoacetate	E
Ethyl Acrylate	L
Ethyl Alcohol (Ethanol)	E
Ethyl Cellulose	E

CHEMICAL SERVICES	
Chemical Composition	Gasket Grade
Ethyl "Cellusolve"	E
Ethyl Chloride	E/T
Ethyl Ether	T
Ethyl Oxalate	E
Ethyl Silicate	T
Ethylene Chlorohydrin	E
Ethylene Diamine	E/T
Ethylene Dichloride (Dichloroethane)	O
Ethylene Glycol	E/T
Ethylene Oxide	NR
Fatty Acid	A
Ferric Chloride, to 35%	E/T/O
Ferric Chloride, Saturated	E
Ferrous Nitrate	V
Ferric Hydroxide	E
Ferric Sulfate	T
Fish Oils (Solubles)	A
Fire Fighting Foam Concentrate	E/O
Fluboric Acid	E/T
Fluorine Gas, Wet	NR
Fluorosilicic Acid, to 30%	V
Fly Ash	E
FM200 HFC-227ea	E
Foam	E
Fog Oil	T
Formaldehyde	E/T
Formamide	E/T
Formic Acid, to 25%	E
Freon 11, 130°F (54°C)	T
Freon 12, 130°F (54°C)	T
Freon 113 130°F (54°C)	T
Freon 114, 130°F (54°C)	T
Freon F-12	T
Freon 123	NR
Freon 134a, 176° (80°C)	E/T
Freon F-21	NR
Freon 22, 130°F (54°C)	V
Fructose	E/T

CHEMICAL SERVICES	
Chemical Composition	Gasket Grade
Fuel Oil	T
Fumaric Acid	E
Furan	NR
Furfuryl Alcohol	E
Gallic Acid	NR
Gasoline, Refined	T
Gasoline, Refined, Unleaded	O
Gelatin	A
Glucose	A
Glue	E/T
Glycerin	E/T
Glycerol	E/T
Glycol	E/T
Glycolic Acid	E
Grease	T/V/O
Green Sulfate Liquor	T
Halon 1301	E
Heptane	T
Hexaldehyde	E
Hexane	T
Hexanol	T
Hexanol Tertiary	T
Hexyl Alcohol	V/T
Hexylene Glycol	T
Hydrobromic Acid, to 40%	E
Hydrochloric Acid, to 36%, 75°F (24°C)	E
Hydrochloric Acid, to 36%, 158°F (70°C)	O
Hydrocyanic Acid	E
Hydrofluoric Acid, to 75%, 75°F (24°C)	O
Hydrofluosilicic Acid	E
Hydrocyanic Acid, to 10%	E
Hydrofluoric Acid, to 30%	V/O
Hydrofluosilicic Acid, to 50%	T
Hydrogen Phosphide	NR
Hydrogen Gas, Cold	E/T
Hydrogen Gas, Hot	E

CHEMICAL SERVICES	
Chemical Composition	Gasket Grade
Hydrogen Peroxide, to 50%	L
Hydrogen Peroxide, to 90%	O
Hydrogen Sulfide	E
Hydroquinone	T/O
Hydroxylamine Sulfate	E
Hypochlorous Acid, Dilute	E
Isododecane	V
Isobutyl Alcohol	E
Iso Octane, 100°F (38°C)	T
Isobutyl Alcohol	E
Isopropyl Acetate	E
Isopropyl Alcohol	E
Isopropyl Ether	T
JP-3	T
JP-4	T/O
JP-5	T/O
JP-6, 7, 8	T
Kerosene	T
Ketones	E
Lactic Acid	A
Lard Oil	V
Latex (1% Styrene & Butadiene)	O
Lauric Acid	T
Lauryl Chloride	NR
Lavender Oil	T
Lead Acetate	T
Lead Chloride	E
Lead Sulfamate	V
Lead Sulfate	T
Lime and H2O	E/T
Lime Sulfur	O
Linoleic Acid	O
Lithium Bromide	T
Lithium Chloride	T
Linseed Oil	A
Lithium Bromide (Brine)	T/O
Lithium Chloride	T/O
Lubricating Oil, Refined	T
Lubricating Oil, Sour	T

CHEMICAL SERVICES	
Chemical Composition	Gasket Grade
Lubricating Oil, to 150°F (66°C)	T
Lubricating Oil, 150°F (66°C) to 180°F (82°C)	V/T
Magnesium Chloride	E/T
Magnesium Hydroxide	E/T
Magnesium Nitrate	E/V
Magnesium Sulfate	E/T
Maleic Acid, Saturate	T
Malic Acid	T
Mercuric Chloride	E/T
Mercuric Cyanide	E/T
Mercurous Nitrate	E/T
Mercury	E/T
Methane	T
Methyl Acetate	V
Methyl Alcohol, Methanol	E/T
Methyl Cellosolve (Ether)	V
Methyl Chloride	O
Methyl Ethyl Ketone	NR
Methyl Isobutyl Carbinol	E
Methylene Chloride	O
Methylene Chlorobromide	NR
Methylene Dichloride 100°F (38°C)	O
MIL-L7808	O
MIL-05606	O
MIL-08515	O
Milk	A
Mineral Oils	T
Naphta	O
Naohthalene	NR
Naptha, 160°F (71°C)	O
Napthenic Acid	T
Natural Gas	T
Nevoil	E
Nickel Acetate to 10%, 100°F (38°C)	V
Nickel mmonium Sulfate	V
Nickel Chloride	E/T
Nickel Nitrate	V

CHEMICAL SERVICES	
Chemical Composition	Gasket Grade
Nickel Plating Solution 125°F (52°C) - Max.	E/T
Nickel Sulfate	E/T
Nitric Acid to 10%, 75°F (24°C) - Max.	E
Nitric Acid, 10-50%, 75°F (24°C) - Max.	O
Nitric Acid, 50-86%, 75°F (24°C)	O
Nitric Acid, Red Fuming	O
Nitrocellulose	V
Nitrogen	E
Nitromethane	E
Nitrous Oxide	E
NOVEC 1230 FK-5-1-12	E
Octyl Alcohol VOGisogiric Acid, to 75%, 150°F (66°C)	O
Oil, Crude Sour	T
Oil, Motor	T
Oleic Acid	T
Oilve Oil	T/A
Oronite 8200 Silicate Ester Fluid	O
Orthodichlorobenzene	O
OS-45 Silicate Ester Fluid	O
OS-45-1	O
Oxalic Acid	E
Oxygen, Cold	E
Ozone (100 ppm)	E
Palm Oil	T/A
Peanut Oil	A
Palmitic Acid	T
Pentane	T
Perchloric Acid	NR
Perchloroethylene	O
Petroleum Ether (see Benzene)	O
Petroleum Oils	T
Phenol (Carbolic Acid)	O
Phenylhydrazine	E
Phenylhydrazine Hydrochloride	E

CHEMICAL SERVICES	
Chemical Composition	Gasket Grade
Phosphate Ester	E
Phosphoric Acid, to 50%	E
Phosphoric Acid, to 75% and 70°F	E/T
Phosphoric Acid, to 85%, 150°F (66°C) - Max.	O
Phosphate Ester	E
Photographic Solutions	T
Phthalic Anhydride	E
Picric Acid	V
Plating Solutions, (gold, brass cadmium, copper, lead, silver, tin, zinc)	V
Polybutene	T
Polyvinyl Acetate, Solid (In Liquid State is 50% solution of Methanol or 60% solution of H2O)	E
Potash	E
Potassium Alum	E/T
Potassium Aluminum Sulfate	E/T
Potassium Bicarbonate	E/T
Potassium Bichromate	E/T
Potassium Borate	E
Potassium Bromate	E
Potassium Bromide	E/T
Potassium Carbonate	E/T
Potassium Chlorate	E
Potassium Chloride	E/T
Potassium Chromate	T
Potassium Cyanide	E/T
Potassium Dichromate	E
Potassium Ferricyanide	E
Potassium Ferrocyanide	E
Potassium Fluoride	E
Potassium Hydroxide	T
Potassium Iodide	V
Potassium Nitrate	E/T
Potassium Perborate	E

CHEMICAL SERVICES	
Chemical Composition	Gasket Grade
Potassium Perchlorate	T
Potassium Permanganate, Saturated to 10%	E
Potassium Permanganate Saturate 10-25%	E
Potassium Persulfate	T
Potassium Silicate	E/T/V
Potassium Sulfate	E/T
Prestone	T
Propane Gas	T
Propanol	E
Propargyl Alcohol	E
Propyl Alcohol	E/T
Propylene Dichloride	L
Propylene Glycol	E
Pydraul F-9 and F-150	NR
Pyranol 1467	T
Pyranol 1476	T
Pyroguard "C"	T
Pyroguard "D"	T
Pyroguard 55	E
Pyrrrole	E
Ref. Fuel (70 ISO Octane, 30 Toluene)	T
Rapeseed Oil	A
Rosin Oil	T/V
Salicylic Acid	E
Secondary Butyl Alcohol	T
Sewage	E/T
Silver Nitrate	E
Silver Sulfate	E
Skydrol, 200°F (93°C) - Max.	L
Skydrol 500 Phosphate Ester	E
Soap Solutions	E/T
Soda Ash, Sodium Carbonate	E/T
Sodium Acetate	E
Sodium Alum	T
Sodium Benzoate	E/T
Sodium Bicarbonate	E/T

CHEMICAL SERVICES	
Chemical Composition	Gasket Grade
Sodium Bisulfate	E/T
Sodium Bisulfite (Black Liquor)	E/T
Sodium Bromide	E/T
Sodium Carbonate	E/T
Sodium Chlorate	E
Sodium Chloride	E/T
Sodium Cyanide	E/T
Sodium Dichromate, to 20%	E/T
Sodium Ferricyanide	E/T
Sodium Ferrocyanide	E/T
Sodium Fluoride	E/T
Sodium Hydroxide, to 15%	E
Sodium Hydro Sulfide	T
Sodium Hydroxide to 50%	E
Sodium Hypochlorite, to 20%	E
Sodium Metaphosphate	T
Sodium Nitrate	E
Sodium Nitrite	E/T
Sodium Perborate	E
Sodium Peroxide	E
Sodium Phosphate	T
Sodium Phosphate, Dibasic	T
Sodium Phosphate, Monobasic	T
Sodium Phosphate, Tribasic	T
Sodium Silicate	T
Sodium Sulfate	E/T
Sodium Sulfide	E/T
Sodium Sulfite Solution, to 20%	T
Sodium Thiosulfate, "Hypo"	T
Sohovis 47	T
Sohovis 78	T
Solvasol #1	T
Solvasol #2	T
Solvasol #3	T
Solvasol #73	T
Solvasol #74	NR
Soybean Oil	A
Spindle Oil	T
Stannic Chloride	T

CHEMICAL SERVICES	
Chemical Composition	Gasket Grade
Stannous Chloride, to 15%	T
Starch	E/T
Steam	NR
Stearic Acid	T
Stoddard Solvent	T
Styrene	O
Sulfonic Acid	E
Sulphite Acid Liquor	E
Sucrose Solutions	A
Sulfur	E/V
Sulfur Chloride	O
Sulfur Dioxide, Dry	E
Sulfur Dioxide, Wet	E
Sulfur Trioxide, Dry	O
Sulfuric Acid, to 25%, 150°F (66°C)	E
Sulfuric Acid, 25-50%, 200°F (93°C)	O
Sulfuric Acid, 50-95%, 150°F (66°C)	O
Sulfuric Acid, Fuming	O
Sulfuric Acid, Oleum	O
Sulfurous Acid	O
Tall Oil	T
Tannic Acid, all conc.	
Tanning Liquors	V
(50g. alum. solution,	
50g. dichromate solution)	T
Tartaric Acid	E
Tertiary Butyl Alcohol	E/T
Tetrabutyl Titanate	E
Tetrachloroethylene	O
Thionyl Chloride	T
Terpineol	V
Tertiary Butyl Alcohol	E/T/V
Tetrachloroethylene	O
Tetrahydrofuran	NR
Tetralin	NR
Thiopene	NR
Titanium Tetrachloride	O
Toluene, to 30%	T
Transmission Fluid, Type A	O

CHEMICAL SERVICES	
Chemical Composition	Gasket Grade
Triacetin	T
Trichloroethane	O
Trichloroethylene	O
Trichloroethylene, to 200°F (93°C)	O
Tricresyl Phosphate	E
Triethanolamine	E/T
Trisodium Phosphate	E
Tung Oil	T
Turbo Oil #15 Diester Lubricant	O
Turpentine	T
Urea	T/E
Vegetable Oils	T/A
Vinyl Acetate	E
Vinegar	A
Vinyl Chloride	O
Vi-Pex	T
Water, to 150°F (66°C)	E/T/M/S
Water, to 200°F (93°C)	E/M
Water, to 230°F (110°C)	E
Water, to 250°F (121°C)	EH
Water, Acid Mine	E/T
Water, Bromine	O
Water, Chlorinated, to 3500 ppm	E
Water, Chlorine	E
Water, Deionized	E/M
Water, Potable	E-pw
Water, Seawater	E
Water, Waste	E/T/M/S
Whiskey	A
White Liquor	E
Wood Oil	T
Xylene	O
Zinc Chloride, to 50%	E
Zinc Nitrate	E
Zinc Sulfate	E/T

INSTALLATION INSTRUCTIONS

2023 Edition

Please read these instructions carefully before installation, assembly or use of any product and keep this manual on hand for future use and reference.

GROOVED COUPLINGS

Gasket Installation - Preliminary Steps -



1. **INSPECT PIPE ENDS:** For optimum sealing by the gasket, the exterior surface of the pipe ends must be free from any indentations, projections, roll marks or other harmful surface defects such as loose paint, scale, dirt, chips, grease and rust.



2. **CHECK GASKET:** Verify the gasket supplied is correct for the intended service. Color code identifies gasket grade.

☞ Refer to page 38 for additional information on gaskets.



3. **LUBRICATE GASKET:** To help insert pipe smoothly and mount couplings smoothly without pinching, apply a thin layer of Shurjoint Lubricant to the sealing lips of the gasket and as well as to the exterior of the gasket. Other compatible lubricants may be used so long as they are not harmful to the gasket. System temperature should also be considered when selecting a lubricant. See page 40 for details.

Note: Lube-E gasket: Normally no lubricant is required when using a Lube-E gasket.



4. **INSTALL GASKET:** Install the gasket over one end of the pipe so that the pipe end is exposed. No part of the gasket should overhang this end of the pipe.

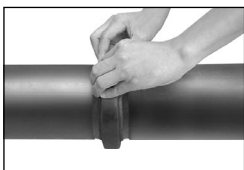

5. **BRING THE MATING PIPE TOGETHER:** Bring together and align the two pipe ends to be joined. Slide the gasket over the ends and center it between the grooves of the pipe to be joined. No part of the gasket should protrude into the groove of either pipe.

Models Z07, Z07N & Z05 Angle Pad Rigid Couplings



Please read these instructions carefully before installation.

1. Refer to page 52 for preliminary steps 1,2,3,4 & 5.

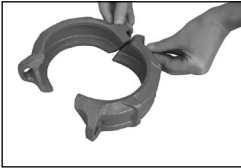
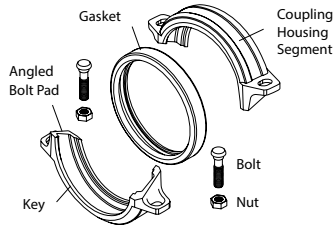

2. **ASSEMBLE COUPLING:** For a "swing-over" assembly loosely install one bolt and nut on one side of the coupling. For a standard assembly start with the two housings separated.

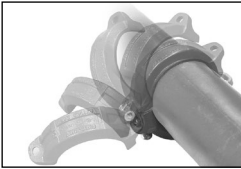

3. **INSTALL COUPLING HALVES:** For a "swing-over" installation, place one of the coupling halves around the bottom side of the gasket and swing over the other coupling half into position over the top side of the gasket. In tight areas where a swing-over is not possible, install the coupling halves one at a time. In both cases make sure the coupling keys are engaged in the grooves.

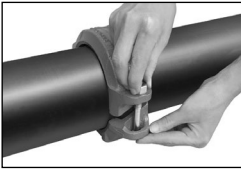

4. **INSERT BOLT & NUT:** Insert the remaining bolt and apply the nut hand-tight. Make sure that the oval neck of the bolt engages into the bolt hole of the housing.



5. **TIGHTEN NUTS** (For 1¼" to 12" Models Z07 and Z05 Couplings and 14" to 24" Model Z07N Couplings): Tighten nuts alternately and equally until the bolt pads meet and make metal-to-metal contact. Tighten nuts by another one quarter to one half turn to make sure the bolts and nuts are snug and secure. The use of a torque wrench is not required.



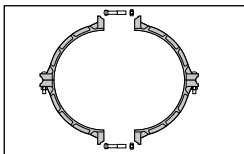

6. **LARGE DIAMETER COUPLING:** When preparing installation on large diameter couplings consisting of three to four housing segments, pre-assemble the segments loosely into two or three equal assemblies depending on sizes. Install those assemblies over the gasket in the same manner as described above.



7. **TIGHTEN NUTS (For 14" to 24" Models Z07 & Z07N Couplings):** Tighten nuts alternately and equally until the bolt pads meet and make metal-to-metal contact. Tighten nuts by another one quarter to one half turn to make sure the bolts and nuts are snug and secure. The use of a torque wrench is not required.



⚠ CAUTION

1. Uneven tightening of bolts and nuts may cause the gasket to be pinched, resulting in an immediate or delayed leak.
2. Never exceed torque stated in the table on page 36. Excessive tightening of nuts may cause a bolt or joint failure.

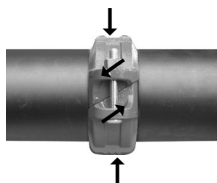

NOTE: As the coupling bolts are tightened, the angled bolt pads slide in opposite directions causing the coupling keys to tightly grip the pipe, while at the same time the pipe grooves are forced outward against the coupling keys. The bolt pads should always maintain metal-to-metal contact. Tighten nuts by another one quarter to one half turn to make sure the bolts and nuts are snug and secure. The use of a torque wrench is not required.

Models 7705, 7705H & 7707 Couplings

Please read these instructions carefully before installation.

1. Refer to page 52 for preliminary steps 1,2,3,4 & 5.

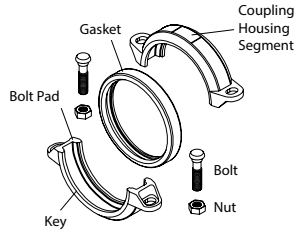

2. **INSTALL COUPLING HALVES:** Place the coupling halves over the gasket and make sure that the coupling keys are engaged into the grooves.



3. **INSERT BOLT & NUT:** Insert the remaining bolt and apply the nuts hand tight. Make sure that the oval neck of the bolt engages into the bolt hole of the housing.



4. **TIGHTEN NUTS** (For $\frac{3}{4}$ " to 12" Models 7705, 7707 Couplings and 14" to 26" Model 7707N Couplings): Tighten nuts alternately and equally until the bolt pads meet and make metal-to-metal contact. Tighten nuts by another one quarter to one half turn to make sure the bolts and nuts are snug and secure. The use of a torque wrench is not required.



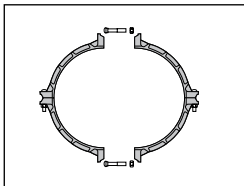

5. **LARGE DIAMETER COUPLING:** (28" to 42" Model 7707L Couplings) Large diameter couplings over 26" consist of six to eight housing segments. To prepare installation, pre-assemble the segments loosely into two or three equal segments depending on sizes. Install those assemblies over the gasket in the same manner as described above.



6. **TIGHTEN NUTS:** Tighten nuts alternately and equally until the bolt pads meet and make metal-to-metal contact. Tighten nuts by another one quarter to one half turn to make sure the bolts and nuts are snug and secure. The use of a torque wrench is not required.



CAUTION

1. Uneven tightening of bolts and nuts may cause the gasket to be pinched, resulting in an immediate or delayed leak.
2. Never exceed torque stated in the table on page 36. Excessive tightening of nuts may cause a bolt or joint failure.

Models K-9, K-9H & 7771 Rigid Couplings Model 7771-T* Transition Coupling



Please read these instructions carefully before installation.

1. Refer to page 52 for preliminary steps 1,2,3,4 & 5.

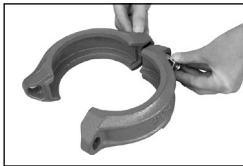
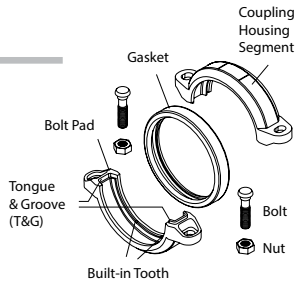

2. **ASSEMBLE COUPLING:** For a “swing-over” assembly loosely install one bolt and nut on one side of the coupling. For a standard assembly start with the two housings separated.



3. **INSTALL COUPLING HALVES:** For a “swing-over” installation, place one of the coupling halves around the bottom side of the gasket and swing over the other coupling half into position over the top side of the gasket. In tight areas where a swing-over is not possible, install the coupling halves one at a time. In both cases make sure the coupling keys are engaged in the grooves.

⚠ WARNING

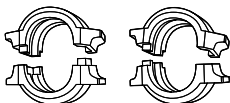

Yes

No

The Shurjoint Models K-9, K-9H, 7771 & 7771-T couplings feature a tongue and groove design and mechanism. Thus the couplings must always be installed so that tongue and groove mate properly. Attempting to install these couplings tongue to tongue or groove to groove will result in joint failure, property damage or serious injury.



4. **INSERT BOLT & NUT:** Insert the remaining bolt and apply the nuts hand tight. Make sure that the oval neck of the bolt engages into the bolt hole of the housing.



5. **TIGHTEN NUTS (For 1¼" to 12" Models K9 and 7771 Couplings):** Tighten nuts alternately and equally until the bolt pads meet and make metal-to-metal contact. Tighten nuts by another one quarter to one half turn to make sure the bolts and nuts are snug and secure. The use of a torque wrench is not required.

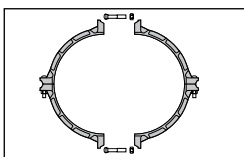

6. **LARGE DIAMETER COUPLING:** Large diameter 7771 couplings over 12" consist of three to four housing segments. To prepare installation, pre-assemble the segments loosely into two or three equal assemblies depending on sizes. Install those assemblies over the gasket in the same manner as described above.

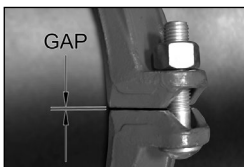

7. **TIGHTEN NUTS (For 14" to 24" Model 7771 Couplings):** Tighten nuts alternately and equally using a torque wrench until the required torque value is achieved. Full metal-to-metal contact is not always required but bolt pad gaps, if any, shall be equal on both sides.

Coupling Size Pipe O.D. in / mm	Required Torque Lbs-Ft / Nm
14" ~ 18"	320 ~ 400
355.6 ~ 457.2	434 ~ 542
20" ~ 24"	360 ~ 520
508.0 ~ 609.6	488 ~ 705

If the bolt pad gaps are greater than $\frac{1}{8}$ " (3.2 mm) at any, or each of the bolt pads, disassemble and reinstall the coupling after checking the following.

- The coupling, pipe and/or fitting being connected are the correct size.
- The coupling keys are fully engaged in the pipe and/or component grooves.
- The gasket is not being pinched.
- The grooves conform to the applicable groove dimension specifications.
- The pipe end flare is within the specification tolerance.

 **CAUTION**

1. Uneven tightening of bolts and nuts may cause the gasket to be pinched, resulting in an immediate or delayed leak.
2. Never exceed torque stated in the table on page 36. Excessive tightening of nuts may cause a bolt or joint failure.

Model R20 Rigid Coupling

Please read these instructions carefully before installation.

1. Refer to page 52 for preliminary steps 1,2,3,4 & 5.

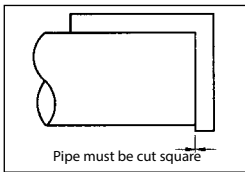
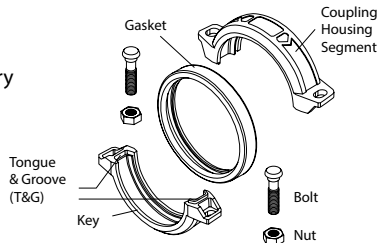
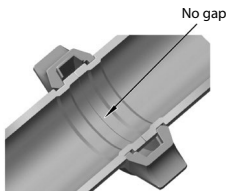

2. **SQAURE CUTTING OF PIPE:** The Model R20 is designed to eliminate the gap between pipes after installation. In order to achieve a butt joint of the pipe ends, the pipe ends must be cut square.



3. **INSTALL COUPLING HALVES:** Place the coupling halves over the gasket and make sure that the coupling keys are engaged into the grooves.



4. **INSERT BOLTS & NUTS:** Insert the bolts and apply the nuts hand tight. Make sure that the oval neck of the bolt engages into the bolt hole of the housing.



5. **TIGHTEN NUTS:** Tighten nuts alternately and equally until the bolt pads meet and make metal-to-metal contact. Tighten nuts by another one quarter to one half turn to make sure the bolts and nuts are snug and secure. The use of a torque wrench is not required.



NOTE: The use of Shurjoint GapSeal gaskets is recommended to enhance the effect of the butt joint and to avoid fluid from entering into the gasket pocket.

CAUTION

1. Uneven tightening of bolts and nuts may cause the gasket to be pinched, resulting in an immediate or delayed leak.
2. Never exceed torque stated in the table on page 36. Excessive tightening of nuts may cause a bolt or joint failure.

Model G-28 Hinged Lever Coupling

Please read these instructions carefully before installation.

1. Refer to page 52 for preliminary steps 1,2,3,4 & 5..

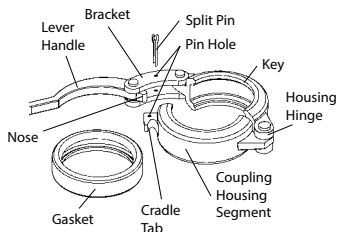

2. APPLY HOUSING: Open the hinged coupling and mount it around the gasket so that the coupling keys are securely engaged into the grooves.

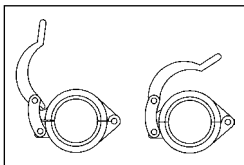

3. ENGAGE HOUSING: Squeeze the housing segments tightly and hook up the nose of the locking handle in the cradle tab of the other housing segment.



4. CLOSE LEVER HANDLE: Firmly close the lever handle and force it down until it touches the back of the housing.

NOTE: If the lever handle is difficult to open or close the use of a section of steel pipe as shown for increased leverage can avoid injury such as pinched fingers.





- 5. INSERT SPLIT PIN:** Insert the split pin through the hole on the bracket of the lever handle to prevent accidental opening of the coupling.

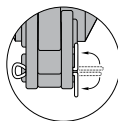

Insert and bend

To Disassemble



- 1. REMOVE THE SPLIT PIN:** Remove the split pin by hand or with the aid of pliers.
- 2. LIFT LEVER HANDLE:** Lift the lever handle to open the coupling. Use a screwdriver or any other similar tool when necessary for initial leverage.

WARNING

Always depressurize and drain the piping system before attempting disassembly of any component. Failure to do so may result in personal injury and/or property damage.

Model XH-70EP Extra Heavy Rigid Coupling

Please read these instructions carefully before installation.

1. Refer to page 52 for preliminary steps 1,2,3,4 & 5.

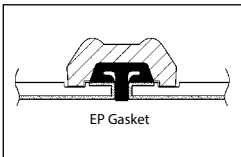
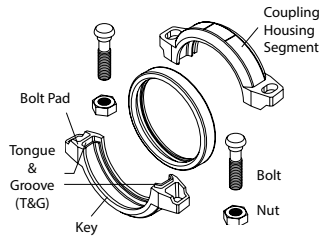

2. Use the Shurjoint factory supplied EP (end protection) gasket.

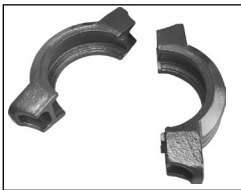

3. ASSEMBLE COUPLING: Start with the two halves separated.

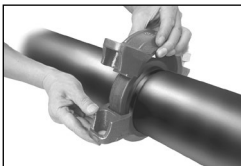

4. ASSEMBLE COUPLING HALVES: Install one half at a time over the gasket ensuring that the coupling keys engage the grooves.

WARNING

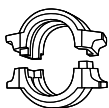

Yes

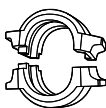

No

The Shurjoint Model XH-70EP couplings feature a tongue and groove design and mechanism. Thus the couplings must always be installed so that tongue and groove mate properly. Attempting to install these couplings tongue to tongue or groove to groove will result in joint failure, property damage or serious injury.



5. **INSERT BOLT & NUT:** Insert the first bolt and apply the nut hand tight. Insert the second bolt and nut in the same manner making sure that the oval neck of both bolts engaged the holes in the coupling housing.



6. **TIGHTEN NUTS:** The XH-70EP assembly has a torque requirement (refer to the table below). Normally you can see some gaps between the bolt pads. Bolt pad gaps should be equal on both sides of the coupling.



Coupling Size Pipe O.D. in / mm	Required Torque Lbs-Ft / Nm
2" ~ 3"	100 ~ 130
60.3 ~ 88.9	135 ~ 175
4"	150 ~ 200
114.3	200 ~ 270
6"	180 ~ 220
168.3	240 ~ 300
8" ~ 10"	200 ~ 225
219.1 ~ 323.9	270 ~ 305

⚠ CAUTION

1. Uneven tightening of bolts and nuts may cause the gasket to be pinched, resulting in an immediate or delayed leak.
2. Never exceed torque stated in the table on page 36. Excessive tightening of nuts may cause a bolt or joint failure.

Model XH-1000 Extra Heavy Rigid Coupling

Please read these instructions carefully before installation.

1. Refer to page 52 for preliminary steps 1,2,3,4 & 5.

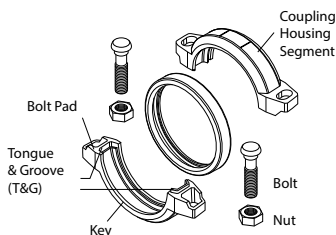

2. ASSEMBLE COUPLING: Start with the two coupling halves separated.

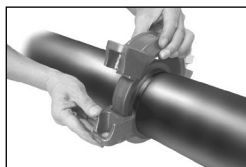

3. ASSEMBLE COUPLING HALVES: Install one half at a time over the gasket making sure that the coupling keys engage the grooves.

WARNING

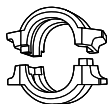

Yes

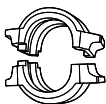

No

The Shurjoint Model XH-1000 couplings feature a tongue and groove design and mechanism. Thus the couplings must always be installed so that tongue and groove mate properly. Attempting to install these couplings tongue to tongue or groove to groove will result in joint failure, property damage or serious injury.

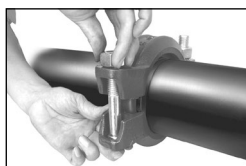

4. INSERT BOLT & NUT: Insert the first bolt and apply the nut hand tight. Insert the second bolt and nut in the same manner making sure that the oval neck of both bolts engage the holes in the coupling housing.



5. **TIGHTEN NUTS:** Sizes 2" through 4" have a torque requirement (refer to the table below). It is normal to see some small gaps between the bolt pads. Bolt pad gaps should be equal on both sides of the coupling.



Coupling Size Pipe O.D. in / mm	Required Torque Lbs-Ft / Nm
2" ~ 3"	100 ~ 130
60.3 ~ 114.3	135 ~ 175
4"	150 ~ 200
60.3 ~ 114.3	200 ~ 270

For sizes 6" to 12", tighten nuts alternately and equally until the bolt pads meet and make metal-to-metal contact. Tighten nuts by another one quarter to one half turn to make sure the bolts and nuts are snug and secure. The use of a torque wrench is not required.



CAUTION

1. Uneven tightening of bolts and nuts may cause the gasket to be pinched, resulting in an immediate or delayed leak.
2. Never exceed torque stated in the table on page 36. Excessive tightening of nuts may cause a bolt or joint failure.

Models 7706 & 7706-T Reducing Coupling

Please read these instructions carefully before installation.

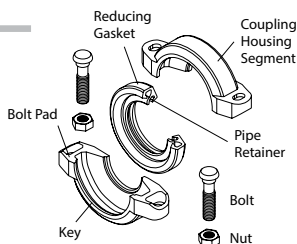

1. **INSPECT PIPE ENDS:** Make sure that two pipes prepared have the right O.D.'s and are properly roll or cut-grooved. For optimum sealing by the gasket, the exterior surface of the pipe ends must be free from any indentations, projections, roll marks or other harmful surface defects such as loose paint, scale, dirt, chips, grease and rust.



2. **CHECK GASKET:** Check the color code of the gasket and make sure that the gasket supplied is correct for the intended service. The standard factory supplied gasket is grade E EPDM, which is green stripe coded and is basically good for water services.

CAUTION

Do not use EPDM gaskets for hydrocarbons or petroleum services as this could result in a leak or joint failure.

 Refer to page 38 for additional information on gaskets.



3. **LUBRICATE GASKET:** To help insert pipe smoothly and mount couplings without pinching, apply a thin layer of Shurjoint Lubricant to the sealing lips of the gasket and as well as to the exterior of the gasket. Other compatible lubricants may be used so long as they are not harmful to the gasket.



4. **MOUNT GASKET ON LARGER PIPE:** Mount the larger opening of the gasket over the larger pipe end.

NOTE: To aid a proper installation, always mount the larger pipe first.



5. **INSERT SMALLER PIPE:** Bring together and align the two pipes to be mated. Insert the smaller pipe into the gasket. A slight twisting motion of the pipe will make for easier assembly. The gasket should not overhang the end of the pipe or the grooves of either pipe.

⚠ CAUTION

The Model 7706 coupling must not be used with an end cap, as the end cap may be sucked into pipe when draining the system.

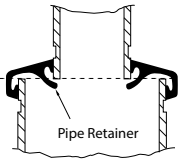

NOTE: No metal washer is required to prevent the smaller pipe from telescoping into the larger pipe. The built-in pipe stopper (or pipe retainer) inside the gasket will help prevent immediate telescoping of the smaller pipe. Nevertheless, careful and gentle insertion of the smaller pipe is required until housings are applied and installation is completed.



6. **INSTALL COUPLING HALVES:** Place the coupling housing segments over the gasket and make sure that the coupling keys are engaged into the grooves.



7. **INSERT BOLT & NUT:** Insert the bolts and apply the nuts hand tight. Make sure that the oval neck of the bolt engages into the bolt hole of the housing.



8. **TIGHTEN NUTS:** Tighten nuts alternately and equally until the bolt pads meet and make metal-to-metal contact. Tighten nuts by another one quarter to one half turn to make sure the bolts and nuts are snug and secure. The use of a torque wrench is not required.



CAUTION

1. Uneven tightening of bolts and nuts may cause the gasket to be pinched, resulting in an immediate or delayed leak.
2. Never exceed torque stated in the table on page 36. Excessive tightening of nuts may cause a bolt or joint failure.

Models C-7 & C-7G Outlet Couplings

Please read these instructions carefully before installation.

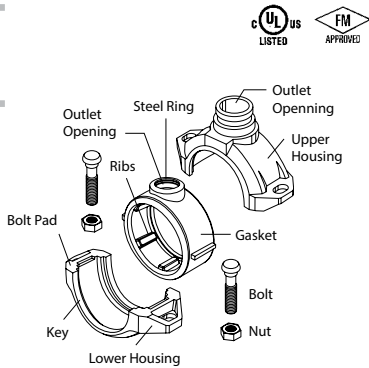

- 1. LUBRICATE GASKET:** Apply a thin layer of Shur-joint or other compatible lubricant to the sealing lips and exterior of the gasket as well as to interior of the coupling housings.

⚠ CAUTION

The C-7/C-7G gasket contains a plated steel ring inside the outlet neck to aid sealing. Do not remove this steel ring as this could result in a leak or joint failure.



- 2. INSTALL GASKET:** Mount the gasket over one end of the pipe so that the gasket lip covers the area between the pipe end and the groove.



- 3. INSERT MATING PIPE:** Insert the mating pipe into the other end of the gasket. Both pipes shall be installed until their ends touch the built-in internal rib of the gasket, which works as a pipe stop. No part of the gasket should protrude into the groove of either pipe.



4. **INSTALL LOWER HOUSING:** Place the lower coupling housing over the gasket around the bottom side of the gasket.

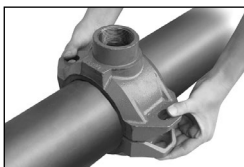

5. **POSITION UPPER HOUSING:** Place the upper coupling housing over the gasket so that the outlet opening of the housing properly fits on gasket outlet opening. Make sure the housing keys engage the pipe grooves.



6. **INSERT BOLT & NUT:** Insert bolts and apply nuts hand tight. Make sure that the oval neck of the bolt engages into the bolt hole of the housing.



7. **TIGHTEN NUTS:** Tighten nuts alternately and equally until the bolt pads meet and make metal-to-metal contact. Tighten nuts by another one quarter to one half turn to make sure the bolts and nuts are snug and secure. The use of a torque wrench is not required.



CAUTION

1. Uneven tightening of bolts and nuts may cause the gasket to be pinched, resulting in an immediate or delayed leak.
2. Never exceed torque stated in the table on page 36. Excessive tightening of nuts may cause a bolt or joint failure.

Model C-7/C-7G Outlet Coupling Flow Characteristics

GROOVED OUTLET	
Outlet Size in / mm	Equivalent Length Feet (meter)
1	9
25	2.7
1¼	4
32	1.2
1½	4
40	1.2
2	13
50	4.0

THREADED OUTLET	
Outlet Size in / mm	Equivalent Length feet (meter)
1	3
25	0.9
1½	3
40	0.9

Feet and meter of Schedule 40 steel outlet pipe with a Hazen-Williams coefficient of friction value of 120.

GROOVED FLANGE ADAPTERS



Models 7041 & 7043 Grooved Flange Adapters (2" - 12")

Please read these instructions carefully before installation.

The Shurjoint Model 7041 flange adapter is drilled to ANSI Class 125/150 and Model 7043 to ANSI Class 300. Model 7041 are also available with drilling to PN10/16 or JIS10K. Please contact Shurjoint for additional information.

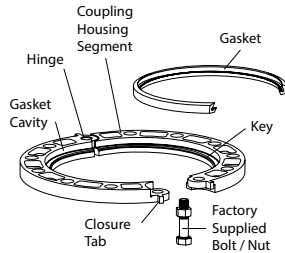

GROOVED FLANGE ADAPTERS

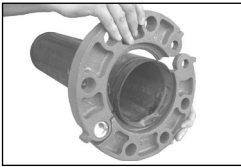

1. MOUNT HINGED FLANGE SEGMENTS: Fully open the Model 7041 or 7043 hinged flange segments. Place the flange segments around the groove of the pipe end and pull together until the mating bolt holes of the ends align.

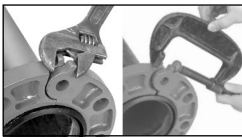

2. DRAW FLANGE SEGMENTS: Use a wrench, C-clamp or other similar tool to draw the closure tabs together until the mating holes are aligned.

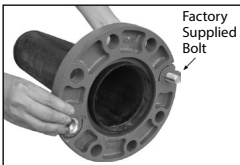

3. INSERT THE FACTORY SUPPLIED BOLT: Insert the Shurjoint factory supplied bolt through the mating hole making sure that the flange is fully engaged in the pipe grooves.

⚠ CAUTION

Use of any bolts other than those supplied with the flange adapter could result in a leak or joint failure.



4. CHECK GASKET GRADE & LUBRICATE: Check the color code of the gasket and make sure that the gasket supplied is correct for the intended service. Then apply a thin layer of Shurjoint Lubricant to the sealing lip of the gasket.

The standard factory supplied gasket is grade E EPDM, which is green stripe coded and is basically good for water services.

⚠ CAUTION

Do not use EPDM gaskets for hydrocarbons or petroleum services as this could result in a leak or joint failure.

☞ Refer to page 38 for additional information on gaskets.

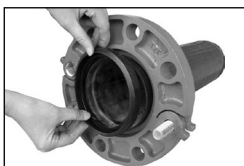

5. INSTALL GASKET: Place the gasket into the gasket cavity between the pipe O.D., and flange recess. Make sure that the bottom of the gasket (the marking side) is positioned and seated against the bottom of the gasket pocket.

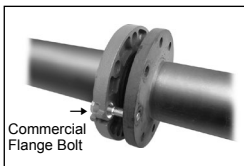

6. MATE ADJOINING FLANGE: Insert commercial flange bolt in the hinge hole (opposite side the factory supplied bolt) and tighten the nuts of the commercial flange bolt and the factory supplied bolt.

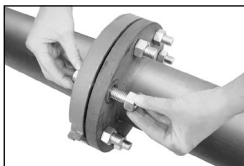

7. ADD BOLTS: Add the remaining commercial flange bolts and apply nuts hand tight. All the bolts shall be inserted from one direction.



8. TIGHTEN NUTS (For 2" to 12" Models 7041 & 7043 Flange Adapters): Tighten nuts alternately in the sequence of diagonally opposite pairs until the flange faces meet and make metal-to-metal contact. Use a torque wrench so that all the nuts are tightened with a same torque value. See page 79 Table 1, Table 1a and Table 2 for required torque values.



Model 7041N Flange Adapter (14" - 24")

Please read the instructions carefully before installation.

1. Refer to page 52 for preliminary steps 1,2,3,4 & 5.

The **Shurjoint** Model 7041 flange adapter is drilled to ANSI Class 125/150. Model 7041 is also available with drilling to PN16. Please contact **Shurjoint** for additional information.

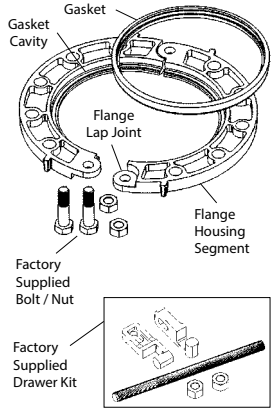

2. **CHECK GASKET GRADE & LUBRICATE:** Check the color code of the gasket and make sure that the gasket supplied is correct for the intended service. Then, apply a thin layer of Shurjoint Lubricant to the sealing lip of the gasket.

The standard factory supplied gasket is grade E EPDM, which is green stripe coded and is basically good for water services.



3. **ASSEMBLE SEGMENT:** Place the half flange segment onto the pipe making sure that the key is engaged in the groove.

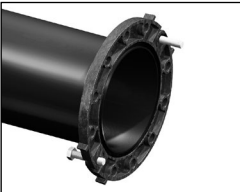

4. **INSERT THE FACTORY SUPPLIED BOLT:** Apply the other half flange segment and insert the Shurjoint factory supplied bolts through the mating holes at the flange lap joints and make sure that the flange is fully engaged in the pipe grooves.

⚠ CAUTION

Use of any bolts other than those supplied with the flange adapter could result in a leak or joint failure.

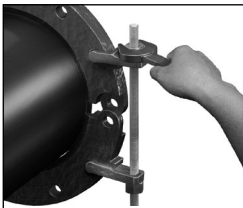

5. **DRAW FLANGE SEGMENTS:** In case it is hard to align the holes at the flange lap joints, use the factory supplied drawer kit to draw the closure tabs together until the mating holes are aligned.

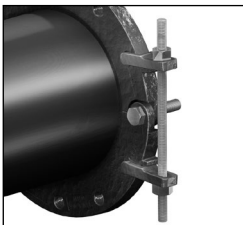

6. **INSERT THE FACTORY SUPPLIED BOLT:** Insert the Shurjoint factory supplied bolt through the mating hole making sure that the flange is fully engaged in the pipe grooves.

CAUTION

Use of any bolts other than those supplied with the flange adapter could result in a leak or joint failure.



7. **INSTALL GASKET:** Place the gasket into the gasket cavity between the pipe O.D., and flange recess. Make sure that the bottom of the gasket (the marking side) is positioned and seated against the bottom of the gasket pocket.

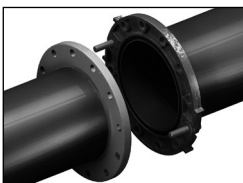

8. **MATE ADJOINING FLANGE:** Bring the adjoining flange face to face with the Model 7041N flange and insert the two factory supplied bolts through the bolt holes at the flange lap joints. Install remaining commercial bolts as needed for flange size.



9. **TIGHTEN NUTS:** Tighten nuts alternately in the sequence of diagonally opposite pairs until the flange faces meet and make metal-to-metal contact. Use a torque wrench so that all the nuts are tightened with the same torque value. See page 79 Table 1, Table 1a and Table 2 for required torque values.





Model 7041 Flange Adapter (14" - 24")

Please read these instructions carefully before installation.

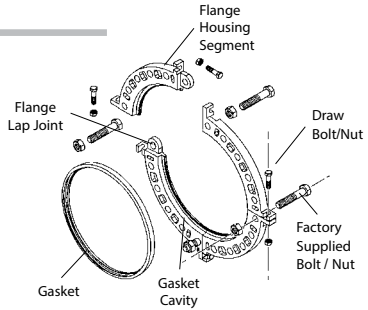

1. ASSEMBLE SEGMENTS: Place the first flange segment onto the pipe making sure that the key is engaged in the groove. As an option, you may put two flange segments together before placing them onto the pipe.

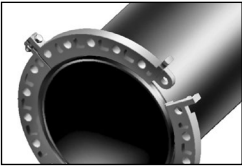

2. ADD OTHER SEGMENTS: Add other flange segments one by one and assemble them with draw bolts. Do not tighten the draw bolt tightly until the final flange segment is brought together and flange alignment is finished.

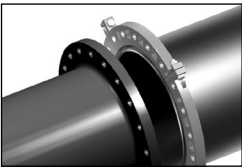

3. ALIGN FLANGE: Bring the two flanges to be mated together and align their bolt holes. It may sometimes be necessary to loosen the draw bolts to allow for easier rotation and alignment. Once the flanges are properly aligned tighten the draw bolts uniformly to make sure the bolts and nuts are snug and secure.

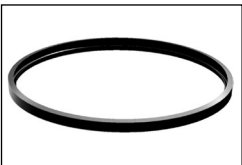

4. CHECK GASKET GRADE & LUBRICATE: Check the color code of the gasket and make sure that the gasket supplied is correct for the intended service. Then, apply a thin layer of Shurjoint Lubricant to the sealing lip of the gasket.

The standard factory supplied gasket is grade E EPDM, which is green stripe coded and is basically good for water services.

⚠ CAUTION

Do not use EPDM gaskets for hydrocarbons or petroleum services as this could result in a leak or joint failure.

☞ Refer to page 38 for additional information on gaskets.

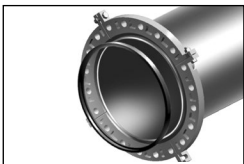

5. **INSTALL GASKET:** Place the gasket into the gasket cavity between the pipe O.D., and flange recess. Make sure that the bottom of the gasket (the marking side) is positioned and seated against the bottom of the gasket pocket.

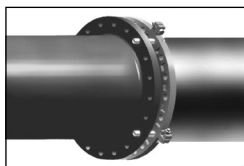

6. **INSERT FACTORY SUPPLIED BOLTS:** Bring the adjoining flange face to face with the Model 7041 flange and insert the four factory supplied bolts through the bolt holes at the flange lap joints.

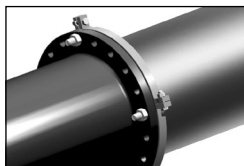

7. **MATE ADJOINING FLANGE:** Apply four nuts on the four factory supplied bolts and provisionally tighten them. Install remaining commercial bolts as needed for flange size.

⚠ CAUTION

Use of any bolts other than those supplied with the flange adapter could result in a leak or joint failure.



8. **TIGHTEN NUTS (For 14" to 24" Model 7041 Flange Adapters):** Tighten nuts alternately in the sequence of diagonally opposite pairs until the flange faces meet and make metal-to-metal contact. Use a torque wrench so that all the nuts are tightened with a same torque value. See page 79 Table 1 and Table 1a for required torque values.



Required Bolt Torque: The table below provides the standard torque values for proper assembly of Shurjoint flange adapters. Use a torque wrench so that all the nuts are tightened equally with a same torque value.

These torque values are not the maximum values and the bolts can be torqued for above the values listed. Attaining maximum torque value is not necessary as the Shurjoint flange adapters are sealed with elastic (rubber) gaskets, which require a much lower torque than that of metallic gaskets.

Table 1: Flange Adapters
Model 7041 (ANSI Class 125/150)

Nom. Size inch	Bolt		Required Torque	
	Size inch	No.	Lbs-Ft	Nm
2	5/8	4	110 ~ 140	149 ~ 190
2½	5/8	4	110 ~ 140	149 ~ 190
3	5/8	4	110 ~ 140	149 ~ 190
4	5/8	8	110 ~ 140	149 ~ 190
5	¾	8	220 ~ 250	298 ~ 339
6	¾	8	220 ~ 250	298 ~ 339
8	¾	8	220 ~ 250	298 ~ 339
10	7/8	12	320 ~ 400	434 ~ 542
12	7/8	12	320 ~ 400	434 ~ 542
14	1	12	360 ~ 520	488 ~ 705
16	1	16	360 ~ 520	488 ~ 705
18	1 1/8	16	450 ~ 725	610 ~ 982
20	1 1/8	20	450 ~ 725	610 ~ 982
24	1 1/4	20	620 ~ 1000	841 ~ 1356

Table 1a: Flange Adapters
Model 7041 (PN 10/16)

Nom. Size inch	Bolt		Required Torque	
	Size inch	No.	Lbs-Ft	Nm
50	M16	4	110 ~ 140	149 ~ 190
65	M16	4	110 ~ 140	149 ~ 190
80	M16	8	110 ~ 140	149 ~ 190
100	M16	8	110 ~ 140	149 ~ 190
125	M20	8	220 ~ 250	298 ~ 339
150	M20	8	220 ~ 250	298 ~ 339
200	M20	12	220 ~ 250	298 ~ 339
250	M24	12	320 ~ 400	434 ~ 542
300	M24	12	320 ~ 400	434 ~ 542
350	M24	16	320 ~ 400	434 ~ 542
400	M27	16	360 ~ 520	488 ~ 705
450	M27	20	360 ~ 520	488 ~ 705
500	M30	20	450 ~ 725	610 ~ 982
600	M33	20	620 ~ 1000	841 ~ 1356

Table 2: Flange Adapters
Model 7043 (ANSI Class 300)

Nom. Size inch	Bolt		Required Torque	
	Size inch	No.	Lbs-Ft	Nm
2	5/8	8	110 ~ 140	149 ~ 190
2½	¾	8	220 ~ 250	298 ~ 339
3	¾	8	220 ~ 250	298 ~ 339
4	¾	8	220 ~ 250	298 ~ 339
5	¾	8	220 ~ 250	298 ~ 339
6	¾	12	220 ~ 250	298 ~ 339
8	7/8	12	320 ~ 400	434 ~ 542
10	1	16	360 ~ 520	488 ~ 705
12	1 1/8	16	450 ~ 725	610 ~ 982

Models 7041 / 7043 Flange Adapters

Important Notes

1. Models 7041 and 7043 flange adapters require a hard flat face for effective sealing. When the mating surface is not adequate as with the serrated faces of some valves or rubber-faced wafer valves, a sandwich plate (Model 49,) must be used.

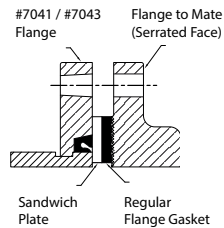
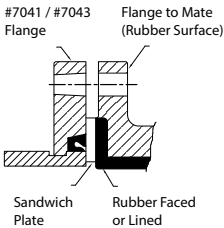
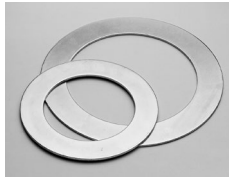

2. The Models 7041 and 7043 flange adapter has small triangular teeth inside the key shoulder to prevent the pipe from rotating.

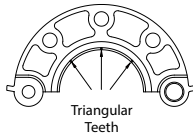

3. Models 7041 and 7043 flange adapters shall not be used as anchor points for tie- rods across non-restrained joints.

4. When assembling a Models 7041 or 7043 flange adapter against a butterfly valve or ball valve, make sure that the outside diameter of the flange adapters do not interfere with the valve actuator or the mounting pad of the actuator.

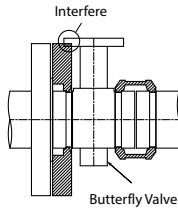

5. Bolt tightening sequence: Like a regular flange joint, it is important to make flange faces contact parallel. Tighten nuts alternately in the sequence of diagonally opposite pairs as shown below until the flange faces meet and make a metal-to- metal contact and required bolt torque is achieved.

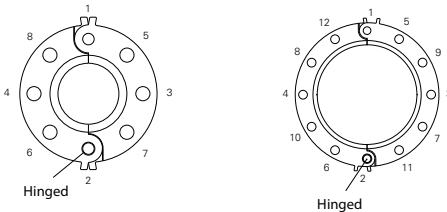

HOLE-CUT PIPING SYSTEM

The hole-cut method of pipe preparation is required when installing the Models 7721, 7722, M21 & M22 Mechanical Tees and Crosses, Model 723 Saddle-Let, Model SS-723 and Model C723 Mechanical Tees.

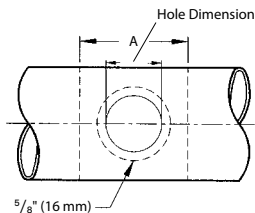

This method of pipe preparation requires the cutting or drilling of a specified hole size on the centerline of the pipe. Always use the correct hole saw size as shown in this handbook and never use a hand torch for cutting a hole. After the hole has been cut all rough edges must be removed and the area within 5/8" (16 mm) of the hole should be inspected to ensure a clean smooth surface, free of any indentations or projections that could affect proper gasket sealing. The area within the "A" dimension should also be inspected and must be free of dirt, scale or any imperfection that could affect proper seating or assembly of the fitting.

CAUTION

The hole must be clearly cut and shall have a smooth edge. Never use a hand torch for cutting a hole as this could affect proper sealing.

Hole Sizes for Mechanical Tees Models 7721, 7722, M21 & M22

Please refer to the table below for specific hole sizes.

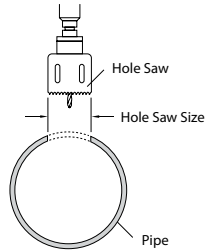

Models 7721 / 7722 / M21 / M22 Mechanical Tee							
Mechanical Tees Run x Branch in / mm	Hole Dimensions A		Surface Preparation in / mm	Mechanical Tees Run x Branch in / mm	Hole Dimensions A		Surface Preparation in / mm
	Hole Saw Size in / mm	Max Dia. Allowed in / mm			Hole Saw Size in / mm	Max Dia. Allowed in / mm	
2 x 1/2	1 1/2	1 5/8	3 1/2	4 x 1	1 1/2	1 5/8	3 1/2
50 x 15	38	41	89	100 x 25	38	41	89
2 x 3/4	1 1/2	1 5/8	3 1/2	4 x 1 1/4	2	2 1/8	4
50 x 20	38	41	89	100 x 32	51	54	102
2 x 1	1 1/2	1 5/8	3 1/2	4 x 1 1/2	2	2 1/8	4
50 x 25	38	41	89	100 x 40	51	54	102
2 x 1 1/4	1 3/4*	1 7/8*	4	4 x 2	2 1/2	2 5/8	4 1/2
50 x 32	45	47	102	100 x 50	64	67	114
2 x 1 1/2	1 3/4*	1 7/8*	4	4 x 2 1/2	2 3/4	2 7/8	4 3/4
50 x 40	45	47	102	100 x 65	70	73	121
2 1/2 x 1/2	1 1/2	1 5/8	3 1/2	4 x 3	3 1/2	3 5/8	5 1/2
65 x 15	38	41	89	100 x 80	89	92	140
2 1/2 x 3/4	1 1/2	1 5/8	3 1/2	5 x 2	2 1/2	2 5/8	4 1/2
65 x 20	38	41	89	125 x 50	64	67	114
2 1/2 x 1	1 1/2	1 5/8	3 1/2	5 x 2 1/2	2 3/4	2 7/8	4 3/4
65 x 25	38	41	89	125 x 65	70	73	121
2 1/2 x 1 1/4	2	2 1/8	4	6 x 1 1/4	2	2 1/8	4
65 x 32	51	54	102	150 x 32	51	54	102
2 1/2 x 1 1/2	2	2 1/8	4	6 x 1 1/2	2	2 1/8	4
65 x 40	51	54	102	150 x 40	51	54	102
3 x 1/2	1 1/2	1 5/8	3 1/2	6 x 2	2 1/2	2 5/8	4 1/2
80 x 15	38	41	89	150 x 50	64	67	114
3 x 3/4	1 1/2	1 5/8	3 1/2	6 x 2 1/2	2 3/4	2 7/8	4 3/4
80 x 20	38	41	89	150 x 65	70	73	121
3 x 1	1 1/2	1 5/8	3 1/2	6 x 3	3 1/2	3 5/8	5 1/2
80 x 25	38	41	89	150 x 80	89	92	140
3 x 1 1/4	2	2 1/8	4	6 x 4	4 1/2	4 5/8	6 1/2
80 x 32	51	54	102	150 x 100	114	118	165
3 x 1 1/2	2	2 1/8	4	8 x 2	2 3/4*	2 7/8*	4 3/4
80 x 40	51	54	102	200 x 50	70	73	121
3 x 2	2 1/2	2 5/8	4 1/2	8 x 2 1/2	2 3/4	2 7/8	4 3/4
80 x 50	64	67	114	200 x 65	70	73	121
4 x 1/2	1 1/2	1 5/8	3 1/2	8 x 3	3 1/2	3 5/8	5 1/2
100 x 15	38	41	89	200 x 80	89	92	140
4 x 3/4	1 1/2	1 5/8	3 1/2	8 x 4	4 1/2	4 5/8	6 1/2
100 x 20	38	41	89	200 x 100	114	118	165

* Important: Make special note of the hole saw size and maximum diameter allowed on these sizes, deviation could lead to joint failure.

Models 7721 & 7722 Mechanical Tees

Please read these instructions carefully before installation.

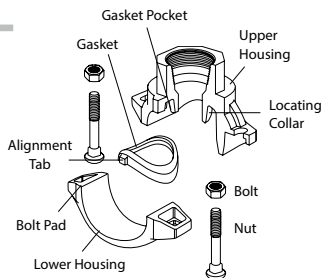

1. HOLE CUT: Determine the location for the hole on the pipe. The hole must be directly positioned in the center of the pipe. Any offset can cause the hole to be obround and cause leakage. Use the correct size hole saw as specified on page 83 for cutting the hole.



2. REMOVE BURRS: Remove burrs and clean the pipe surface within $\frac{5}{8}$ " (16 mm) around the hole where the gasket is to be seated.

CAUTION

The hole must be cleanly cut and shall have a smooth edge. Never use a hand torch for cutting a hole as this could affect proper sealing.



3. CHECK GASKET GRADE AND LUBRICATE: Check the color code of the gasket and make sure that the gasket supplied is correct for the intended service. Then, apply a thin layer of Shurjoint Lubricant to the sealing lip of the gasket.

The standard factory supplied gasket is grade E EPDM, which is green stripe coded and is basically good for water services.

⚠ CAUTION

Do not use EPDM gaskets for hydrocarbons or petroleum services as this could result in a leak or joint failure.

☞ Refer to page 38 or additional information on gaskets.

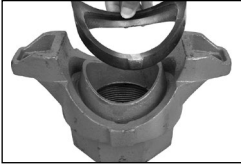

4. **INSERT GASKET:** Insert the gasket into the gasket pocket of the housing. The alignment tabs on the side of the gasket should properly fit into the recesses.

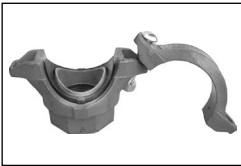

5. **PREPARE TO ASSEMBLE:** Assemble the coupling housings loosely leaving one nut and bolt off to allow for a "swing-over" installation.

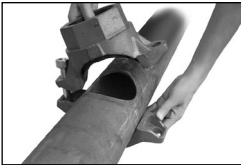

6. **POSITION UPPER HOUSING:** Place the upper housing on the pipe so that the locating collar engages properly into the hole. Then apply the lower housing from the opposite side of the pipe.

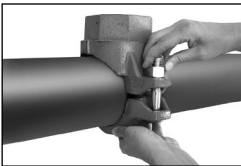

7. **INSERT BOLT & NUT:** Insert the remaining bolt and apply the nut hand-tight. Make sure that the oval neck of the bolt engages into the bolt hole of the housing.



8. **CHECK LOCATING COLLAR:** Double check to ensure the locating collar is properly seated in the hole. This may be checked by rocking the upper housing in the hole. Also make sure that the oval neck of the bolts engages into the bolt hole of the housing.



9. TIGHTEN NUTS: Tighten nuts alternately and equally until the outlet housing comes to contact the outer surface of the pipe, metal-to-metal contact. Gaps between bolt pads are acceptable but the gaps shall be equal on both sides. Use a torque wrench and tighten the nuts to following torque values.

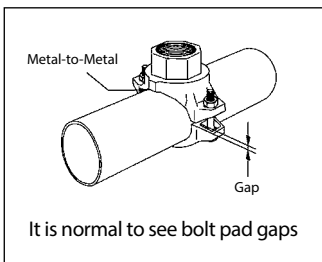

Models 7721 & 7722 Mechanical Tees

Nom. Size in / mm	Bolt		Required Torque Lbs-Ft / Nm
	Size inch	No.	
2 / 50	3/8	2	30 / 40
2½ / 65	½	2	50 / 68
3 / 80	½	2	
4 / 100	½	2	
5 / 125	5/8	2	
6 / 150	5/8	2	
8 / 200	¾	2	

⚠ CAUTION

Do not exceed the above torque values by more than 25% as excessive torque could lead to bolt and/or joint failure.

Outlet Flow Characteristics for Mechanical Tee Models 7721 & 7722

Outlet Size in / mm	Equivalent Length		Outlet Size in / mm	Equivalent Length	
	#7721 feet / meter	#7722 feet / meter		#7721 feet / meter	#7722 feet / meter
1	3.0	3.0	2½	15.0	15.0
25	0.9	0.9	65	4.6	4.6
1¼	6.0	6.0	3	16.0	16.0
32	1.8	1.8	80	4.9	4.9
1½	8.0	8.0*	4	17.0	17.0
40	2.4	2.4	100	5.2	5.2
2	9.0	9.0			
50	2.7	2.7			

Feet and meter of Schedule 40 steel outlet pipe with a Hazen-Williams coefficient of friction value of 120.

*Equivalent length for #7721 with a 1½" outlet and 2" or 2½" main run size is 13 feet (4 meters)

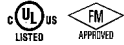

Models M21 & M22 Mechanical Tees

Please read these instructions carefully before installation.

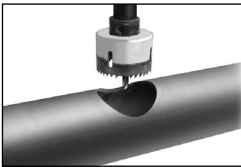
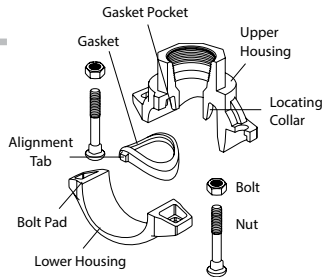

1. HOLE CUT: Determine the location for the hole on the pipe. Use the correct size hole saw as specified on page 83 for cutting the hole.



2. REMOVE BURRS: Remove burrs and clean the pipe surface within $\frac{5}{8}$ " (16 mm) around the hole where the gasket is to be seated.

CAUTION

The hole must be cleanly cut and shall have a smooth edge. Never use a hand torch for cutting a hole as this could affect proper sealing.



3. CHECK GASKET GRADE AND LUBRICATE: Check the color code of the gasket and make sure that the gasket supplied is correct for the intended service. Then, apply a thin layer of Shurjoint Lubricant to the sealing lip of the gasket.

The standard factory supplied gasket is grade E EPDM, which is green stripe coded and is basically good for water services.

Refer to page 38 for additional information on gaskets.

 CAUTION

Do not use EPDM gaskets for hydrocarbons or petroleum services as this could result in a leak or joint failure.



4. INSERT GASKET: Insert the gasket into the gasket pocket of the housing. The alignment tabs on the side of the gasket should properly fit into the recesses.



5. PREPARE TO ASSEMBLE: Assemble the coupling housings loosely leaving one nut and bolt off to allow for a “swing-over” installation.



6. POSITION UPPER HOUSING: Place the upper housing on the pipe so that the locating collar engages properly into the hole. Then apply the lower housing from the opposite side of the pipe.

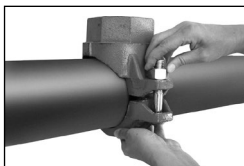

7. INSERT BOLT & NUT: Insert the remaining bolt and apply the nut hand-tight. Make sure that the oval neck of the bolt engages into the bolt hole of the housing.

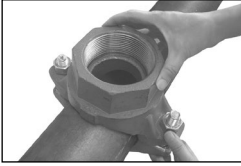

8. CHECK LOCATING COLLAR: Double check to ensure the locating collar is properly seated in the hole. This may be checked by rocking the upper housing in the hole. Also make sure that the oval neck of the bolts engages into the bolt hole of the housing.



9. TIGHTEN NUTS: Tighten nuts alternately and equally until the outlet housing comes to contact the outer surface of the pipe, metal-to-metal contact. Gaps between bolts pads are acceptable but the gaps shall be equal on both sides. Use a torque wrench and tighten the nuts to following torque values.

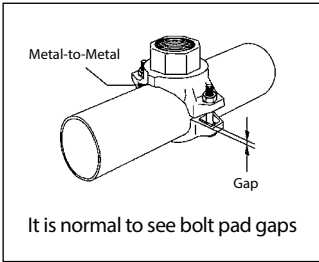

Models M21 & M22 Mechanical Tees

Nom. Size in / mm	Bolt		Required Torque Lbs-Ft / Nm
	Size inch	No.	
2 / 50	$\frac{3}{8}$	2	50 / 68
2½ / 65	$\frac{1}{2}$	2	
3 / 80	$\frac{1}{2}$	2	
4 / 100	$\frac{1}{2}$	2	
5 / 125	$\frac{5}{8}$	2	
6 / 150	$\frac{5}{8}$	2	
8 / 200	$\frac{3}{4}$	2	

Models 723 & SS-723 Saddle-let Small Mechanical Tees

Please read these instructions carefully before installation.

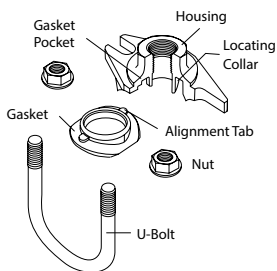

1. HOLE CUT: Determine the location for the hole on the pipe. Use a $1\frac{3}{16}$ " (30 mm) hole saw and cut a hole at the desired location. The hole must be directly positioned in the center of the pipe. Any offset can cause the hole to be obround and cause leakage.

Hole Sizes for Mechanical Tees Models 723 & SS-723

Model 723 Saddle-Let, Models SS-723 Mechanical Tee				
Header Size in / mm	Branch Size in / mm	Hole Dimensions		Surface Preparation * "A" in / mm
		Hole Saw Size in / mm	Max Dia. Allowed in / mm	
1¼	½, ¾, 1	1¾ ₁₆	1¼	3½
32	15, 20, 25	30	32	89
1½	½, ¾, 1	1¾ ₁₆	1¼	3½
40	15, 20, 25	30	32	89
2	½, ¾, 1	1¾ ₁₆	1¼	3½
50	15, 20, 25	30	32	89
2½	½, ¾, 1	1¾ ₁₆	1¼	3½
65	15, 20, 25	30	32	89

* Please refer to page 83.

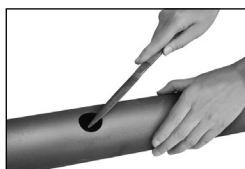

2. REMOVE BURRS: Remove burrs and clean the pipe surface within $\frac{5}{8}$ " (16 mm) around the hole where the gasket is to be seated

⚠ CAUTION

The hole must be cleanly cut and shall have a smooth edge. Never use a hand torch for cutting a hole as this could affect proper sealing.



3. INSERT GASKET: Insert the gasket into the gasket pocket of the housing using alignment tabs on side for proper positioning.

⚠ CAUTION

Do not use EPDM gaskets for hydrocarbons or petroleum services as this could result in a leak or joint failure.

☞ Refer to page 38 for additional information on gaskets.



4. POSITION LOCATING COLLAR: Position the upper housing on the pipe so that the built-in locating collar fits properly within the hole.

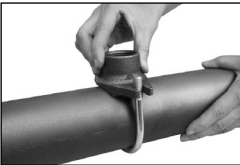

5. INSERT BOLT: Insert the U-bolt from the opposite side of the pipe and apply the nuts hand tight.



NOTE: For SS-723, insert the lower housing from the opposite side of the pipe and apply the bolts and nuts hand tight.



6. TIGHTEN NUT: Check to make sure the locating collar is properly seated in the hole. Tighten the nuts alternately and equally to an approximate torque value of 22 Lbs-Ft (30 Nm).



⚠ CAUTION

Excessive torque may lead to gasket distortion, leaks and/or joint failure. To avoid excessive torque use a wrench with a maximum length of 8" (200 mm).

Outlet Flow Characteristics for Models 723 & SS-723

Outlet Size in / mm	Equivalent Length feet / meter
1	1.2
25	40

Feet and Meter of Schedule 40 steel outlet pipe with a Hazen-Williams coefficient of friction value of 120.

STAINLESS STEEL COUPLINGS

How to Install Gaskets - Preliminary Steps -



1. **INSPECT PIPE ENDS:** For optimum sealing by the gasket, the exterior surface of the pipe ends must be free from any indentations, projections, roll marks or other harmful surface defects such as loose paint, scale, dirt, chips, grease and rust. Insure that the groove has well defined vertical walls.

Groove corners are not defined

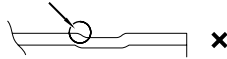

2. **CHECK GASKET:** Check the color code of the gasket and make sure that the gasket supplied is correct for the intended service. The standard factory supplied gasket is grade E EPDM, which is green stripe coded and is basically good for water services.

⚠ CAUTION

Do not use EPDM gaskets for hydrocarbons or petroleum services as this could result in a leak or joint failure.

☞ Refer to page 38 for additional information on gaskets.



3. **LUBRICATE GASKET:** Apply a thin layer of Shur-joint Lubricant to the sealing lips of the gasket and as well as to the exterior of the gasket.



4. **INSTALL GASKET:** Install the gasket over one end of the pipe so that the pipe end is exposed. No part of the gasket should overhang this end of the pipe.

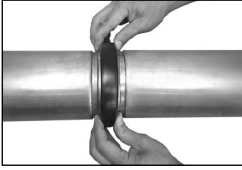

5. BRING THE MATING PIPE TOGETHER: Bring together and align the two pipe ends to be joined. Slide the gasket over the ends and center it between the grooves of the pipe to be joined. No part of the gasket should protrude into the groove of either pipe.

Model SS-5 Stainless Steel Angle Pad Rigid Couplings

Please read these instructions carefully before installation.

1. Refer to page 93 for preliminary steps 1,2,3,4 & 5.

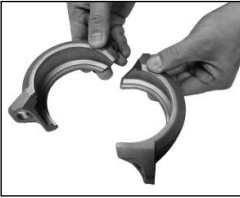
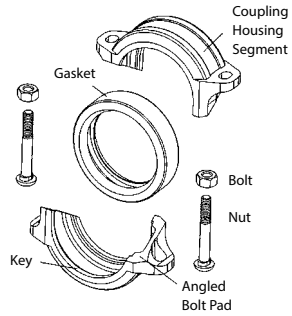

2. **ASSEMBLE COUPLING:** For a “swing-over” assembly loosely install one bolt and nut on one side of the coupling. For a standard assembly start with the two housings separated.

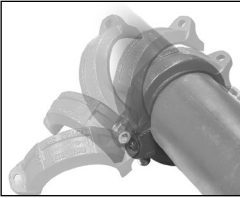

3. **INSTALL COUPLING HALVES:** For a “swing-over” installation, place one of the coupling halves around the bottom side of the gasket and swing over the other coupling half into position over the top side of the gasket. In tight areas where a swing-over is not possible, install the coupling halves one at a time. In both cases make sure the coupling keys are engaged in the grooves.



4. **INSERT BOLT & NUT:** Insert the remaining bolt and apply the nut hand-tight. Make sure that the oval neck of the bolt engages into the bolt hole of the housing.



5. **TIGHTEN NUTS:** Tighten nuts alternately and equally until the bolt pads meet and make metal-to-metal contact. Tighten nuts by another one quarter to one half turn to make sure the bolts and nuts are snug and secure. The use of a torque wrench is not required.



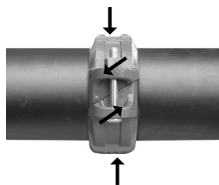

NOTE: As the coupling bolts are tightened, the angled bolt pads slide in opposite directions causing the coupling keys to tightly grip the pipe, while at the same time the pipe grooves are forced outward against the coupling keys. The bolt pads should always maintain metal-to-metal contact. Tighten nuts by another one quarter to one half turn to make sure the bolts and nuts are snug and secure. The use of a torque wrench is not required.

 CAUTION

1. Uneven tightening of bolts and nuts may cause the gasket to be pinched, resulting in an immediate or delayed leak.
2. Never exceed torque stated in the table on page 36. Excessive tightening of nuts may cause bolt or joint failure.

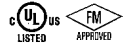

Models SS-7 & SS-7X* Stainless Steel Rigid Couplings

Please read these instructions carefully before installation.

1. Refer to page 93 for preliminary steps 1,2,3,4 & 5.

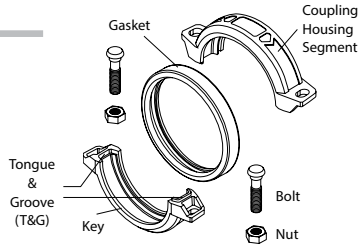

2. INSTALL COUPLING HALVES: Place the coupling halves over the gasket and make sure that the coupling keys are engaged into the grooves.

⚠ WARNING

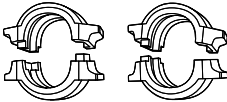

Yes

No

The Shurjoint Models SS-7 & SS-7X couplings feature a tongue and groove design and mechanism. Thus the couplings must always be installed so that tongue and groove mate properly. Attempting to install these couplings tongue to tongue or groove to groove will result in joint failure, property damage or serious injury.



3. INSERT BOLT & NUT: Insert bolts and apply nuts hand tight. Make sure that the oval neck of the bolt engages into the bolt hole of the housing.



4. **TIGHTEN NUTS** (For 1¼" to 8" Model SS-7 Couplings): Tighten nuts alternately and equally until the bolt pads meet and make metal-to-metal contact. Tighten nuts by another one quarter to one half turn to make sure the bolts and nuts are snug and secure. The use of a torque wrench is not required.

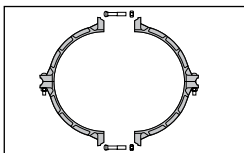

5. **LARGE DIAMETER COUPLING**: Large diameter couplings over 14" consist of three to four housing segments. To prepare installation, preassemble the segments loosely into two or three equal assemblies depending on sizes. Install those assemblies over the gasket in the same manner as described above.

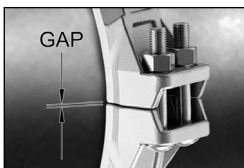

6. **TIGHTEN NUTS** (For 10" to 24" Model SS-7X Couplings): The SS-7X assembly has a torque requirement (refer to the table below). Normally you can see some gaps between the bolt pads. Bolt pad gaps should be equal on all bolt pads of the coupling.



Nominal Size Pipe O.D. in / mm	Required Torque Lbs-Ft / Nm
10	105-175
273.0	145-235
12	105-175
323.9	145-235
10	105-175
267.4	145-235
12	105-175
318.5	145-235
14	105-175
355.6	145-235
16	50-75
406.4	68-100
18	50-75
457.2	68-100
20	65-150
508.0	85-200
22	65-150
558.8	85-200
24	65-150
609.6	85-200

If the bolt pad gaps are greater than $\frac{1}{8}$ " (3.2 mm), disassemble and reinstall the coupling after checking the following.

- The coupling, pipe and/or fitting being connected are the correct size.
- The coupling keys are fully engaged in the pipe and/or component grooves.
- The gasket is not being pinched.
- The grooves conform to the applicable groove dimension specifications.
- The pipe end flare is within the specification tolerance.

NOTE: Excessive torque may cause the galling of stainless steel bolts and nuts. Use of an anti-seize lubricant such as Loctite C5-A to lessen this problem with stainless steel bolts and nuts. The use of silicone bronze nuts is also a good option to avoid galling. Contact Shurjoint for additional information.

 **CAUTION**

1. Uneven tightening of bolts and nuts may cause the gasket to be pinched, resulting in an immediate or delayed leak.
2. Never exceed torque stated in the table on page 98. Excessive torque may lead to bolt or joint failure.

* SS-7X is not UL listed.

Models SS-8 & SS-8X* Stainless Steel Standard Couplings

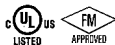

Please read these instructions carefully before installation.

1. Refer to page 93 for preliminary steps 1,2,3,4 & 5.

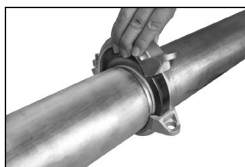
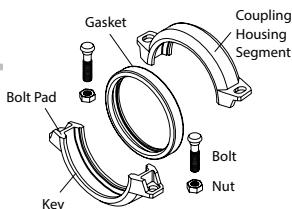

2. **INSTALL COUPLING HALVES:** Place the coupling halves over the gasket and make sure that the coupling keys are engaged into the grooves.



3. **INSERT BOLT & NUT:** Insert bolts and apply nuts hand tight. Make sure that the oval neck of the bolt engages into the bolt hole of the housing.



4. **TIGHTEN NUTS:** Tighten nuts alternately and equally until the bolt pads meet and make metal-to-metal contact. Tighten nuts by another one quarter to one half turn to make sure the bolts and nuts are snug and secure. The use of a torque wrench is not required.



NOTE: Excessive torque may cause the galling of stainless steel bolts and nuts. Use of an anti-seize lubricant such as Loctite C5-A to lessen this problem with stainless steel bolts and nuts. The use of silicone bronze nuts is also a good option to avoid galling. Contact Shurjoint for additional information.

CAUTION

1. Uneven tightening of bolts and nuts may cause the gasket to be pinched, resulting in an immediate or delayed leak.
2. Never exceed torque stated in the table on page 98. Excessive torque may lead to bolt or joint failure.

Model SS-1200 Stainless Steel Flexible Coupling

Please read these instructions carefully before installation.

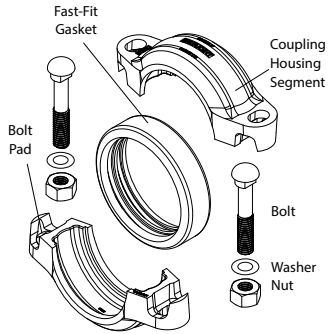

The Shurjoint Model SS-1200 is designed for high pressure applications including reverse osmosis and desalination systems. The coupling is supplied standard a proprietary Shurjoint Fast-Fit gasket, type 316 track bolts, washers and silicone bronze nuts. The SS-1200 performance standards are based on use with cut groove pipe ends only.

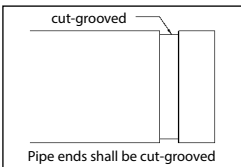

1. CUT GROOVE PIPE ENDS: Cut groove the pipe ends to be connected. The performance standards do not support use with roll-grooved pipe ends.

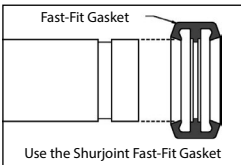

2. CHECK GASKET: Always use the factory supplied Shurjoint Fast-Fit gasket. Performance standards do not support the use of a standard gasket in the SS-1200 coupling. Use of a lubricant is usually not required. In systems, subject to extreme hot or cold temperatures, the use of Shurjoint EHC silicone lube is recommended. If a lubricant is used make sure to use the Shurjoint or other compatible NSF 61 approved lubricant.

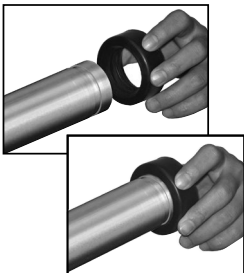

Easy installation with a single hand

3. MOUNT GASKET ON PIPE ENDS: Insert one pipe end into the Fast-Fit gasket, then insert the other pipe end to be connected into the other side of the gasket. The Fast-Fit gasket design allows for the direct insertion of the pipe ends into the gasket without stretching the gasket.



4. INSTALL COUPLING HALVES: Place the coupling halves over the gasket and make sure that the coupling keys are engaged into the grooves.

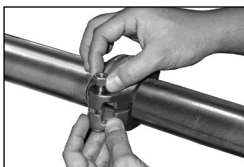

5. INSERT BOLT & NUT: Insert the factory supplied bolt through the bolt pads. Place the washer over the bolt and assemble the silicone bronze nut (hand tight) on the bolt. The use of other bolts and nuts could lead to joint failure or galling.



6. TIGHTEN NUTS: Tighten nuts alternately and equally until the bolt pads meet and make metal-to-metal contact. Tighten nuts by another one quarter to one half turn to make sure the bolts and nuts are snug and secure. The use of a torque wrench is not required.



NOTE: When joining the SS-41 to carbon steel flanges it is recommended that a dielectric flange kit be used. Use of a stainless-steel Model 49 sandwich plate may be necessary to insure a proper seal with dielectric flange gaskets.

Model SS-28 Stainless Steel Hinged Lever Coupling

Please read these instructions carefully before installation.

1. Refer to page 93 for preliminary steps 1,2,3,4 & 5.

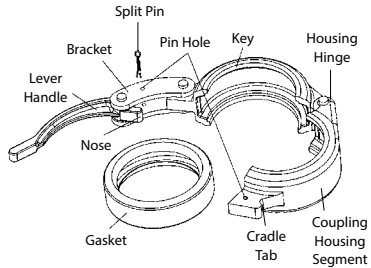

2. **APPLY HOUSING:** Open the hinged coupling and mount it around the gasket so that the coupling keys are securely engaged into the grooves.

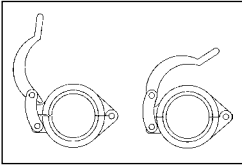

3. **ENGAGE HOUSING:** Squeeze the housing segments tightly and hook up the nose of the locking handle in the cradle tab of the other housing segment.



4. **CLOSE LEVER HANDLE:** Lift the lever handle and force it down until it touches the back of the housing.

NOTE: If the lever handle is difficult to open or close the use of a section of steel pipe as shown for increased leverage can avoid injury such as pinched fingers.





5. **INSERT SPLIT PIN:** Insert the split pin through the hole on the bracket of the lever handle and bend to prevent accidental opening of the coupling.

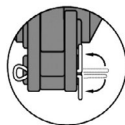

Insert and Bend

To Disassemble



1. **REMOVE THE SPLIT PIN:** Remove the split pin by hand or with the aid of pliers.

2. **LIFT LEVER HANDLE:** Lift the lever handle to open the coupling. Use a screwdriver or any other similar tool when necessary for initial leverage.

WARNING

Always depressurize and drain the piping system before attempting disassembly of any component.



Model SS-41 Stainless Steel Flange Adapter

Please read these instructions carefully before installation.

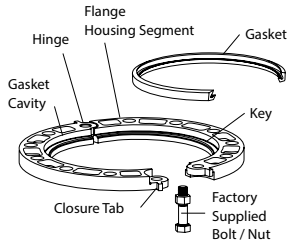

NOTE: The Shurjoint Model SS-41 flange adapter is drilled to ANSI Class 125/150.

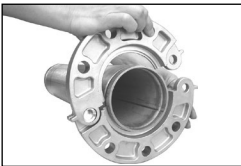

1. MOUNT HINGED FLANGE SEGMENTS: Fully open the Model SS-41 hinged flange segments. Place the flange segments around the groove of the pipe end and pull together until the mating bolt holes of the ends come to align.

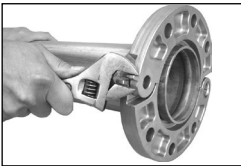

2. DRAW FLANGE SEGMENTS: Use a wrench, C-clamp or other similar tool to draw the closure tabs together until the mating holes are aligned.

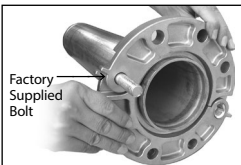

3. INSERT THE FACTORY SUPPLIED BOLT: Insert the Shurjoint factory supplied bolt through the mating hole making sure that the flange is fully engaged in the pipe grooves.

CAUTION

Use of any bolt other than the one supplied with the flange adapter could result in a leak or joint failure.



4. CHECK GASKET GRADE & LUBRICATE: Check the color code of the gasket and make sure that the gasket supplied is correct for the intended service. Then, apply a thin layer of Shurjoint Lubricant to the sealing lip of the gasket.

The standard factory supplied gasket is grade E EPDM, which is green stripe coded and is basically good for water services.

⚠ CAUTION

Do not use EPDM gaskets for hydrocarbons or petroleum services as this could result in a leak or joint failure.

☞ Refer to page 38 for additional information on gaskets.

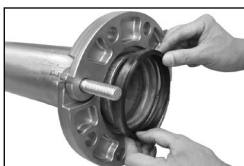

5. INSTALL GASKET: Place the gasket into the cavity between the pipe O.D., and flange recess. Make sure that the bottom of the gasket (the marking side) is positioned and seated against the bottom of the flange recess.

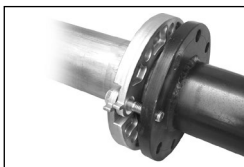

6. MATE ADJOINING FLANGE: Insert commercial flange bolt in the hinge hole (opposite side the factory supplied bolt) and tighten the nuts of the commercial flange bolt and the factory supplied bolt.

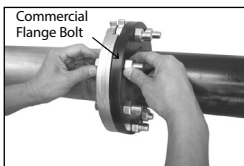

7. ADD BOLTS: Add the remaining commercial flange bolts and apply nuts hand tight. All the bolts shall be inserted from the same direction.



8. **TIGHTEN NUTS:** Tighten nuts alternately in the sequence of diagonally opposite pairs until the flange faces meet and make metal-to-metal contact. Use a torque wrench so that all the nuts are tightened with a same torque value.



Required Bolt Torque: The table below provides the standard torque values for proper assembly of Shurjoint flange adapters. Use a torque wrench so that all the nuts are tightened equally with a same torque value.

These torque values are not the maximum values and the bolts can be torqued for above the values listed. Attaining maximum torque value is not necessary as the Shurjoint flange adapters are sealed with elastic (rubber) gaskets, which require a much lower torque than that of metallic gaskets.

Shurjoint Flange Adapter ANSI Class 125/150
Model SS-41

Nom. Size inch	Bolt		Required Torque	
	Size inch	No.	Lbs-Ft	Nm
2	$\frac{5}{8}$	4	110 ~ 140	149 ~ 190
2½	$\frac{5}{8}$	4	110 ~ 140	149 ~ 190
3	$\frac{5}{8}$	4	110 ~ 140	149 ~ 190
4	$\frac{5}{8}$	8	110 ~ 140	149 ~ 190
5	$\frac{3}{4}$	8	220 ~ 250	298 ~ 339
6	$\frac{3}{4}$	8	220 ~ 250	298 ~ 339
8	$\frac{3}{4}$	8	220 ~ 250	298 ~ 339
10	$\frac{7}{8}$	12	320 ~ 400	434 ~ 542
12	$\frac{7}{8}$	12	320 ~ 400	434 ~ 542
14	1	12	360 ~ 520	488 ~ 705
16	1	16	360 ~ 520	488 ~ 705
18	$1\frac{1}{8}$	16	450 ~ 725	610 ~ 982
20	$1\frac{1}{8}$	20	450 ~ 725	610 ~ 982
24	$1\frac{1}{4}$	20	620 ~ 1000	841 ~ 1356

NOTE: When joining the SS-41 to carbon steel flanges it is recommended that a dielectric flange kit be used. Use of a stainless-steel Model 49 sandwich plate may be necessary to insure a proper seal with dielectric flange gaskets.

COPPER TUBING SERIES

How to Install Gaskets - Preliminary Steps -



1. **INSPECT PIPE ENDS:** For optimum sealing by the gasket, the exterior surface of the pipe ends must be free from any indentations, projections, roll marks or other harmful surface defects such as loose paint, scale, dirt, chips, grease and rust.



2. **CHECK GASKET:** Check the color code of the gasket and make sure that the gasket supplied is correct for the intended service. The standard factory supplied gasket for the copper series is a grade E-pw GapSeal gasket for potable water applications (double green stripe).

CAUTION

Do not use EPDM gaskets for hydrocarbons or petroleum services as this could result in a leak or joint failure.

 Refer to page 38 for additional information on gaskets.



3. **LUBRICATE GASKET:** Apply a thin layer of Shurjoint Lubricant to the sealing lips of the gasket as well as to the exterior of the gasket. For potable water applications a NSF 61 approved lubricant must be used. If you are not using Shurjoint Lubricant make sure the lubricant you are using is NSF 61 approved. In systems, subject to extreme hot or cold temperatures, the use of Shurjoint EHC silicone lube is recommended.



4. **INSTALL GASKET:** Install the gasket over one end of the pipe so that the pipe end is exposed. No part of the gasket should overhang this end of the pipe.

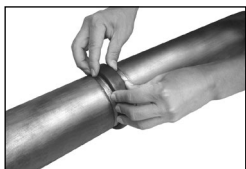

5. **BRING THE MATING PIPE TOGETHER:** Bring together and align the two pipe ends to be joined. Slide the gasket over the ends and center it between the grooves of the pipes to be joined. No part of the gasket should protrude into the groove of either pipe.

Model C305 Rigid Coupling

Please read these instructions carefully before installation.

1. Refer to page 108 for preliminary steps 1,2,3,4 & 5.

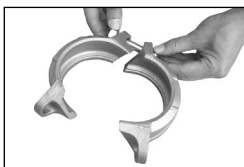
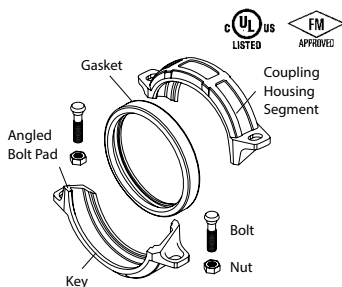

2. **ASSEMBLE COUPLING:** If assembled remove one nut and bolt from one side of the coupling and loosen the nut on the opposite side. If unassembled loosely install one bolt and nut on one side of the coupling. This assembly with one bolt and nut allows for a "swing-over" installation.



3. **INSTALL COUPLING HALVES:** Place one of the coupling halves over the gasket and swing-over the other coupling half into position. Make sure that the coupling keys are engaged into the grooves.



4. **INSERT BOLT & NUT:** Insert the remaining bolt and apply the nut hand-tight. Make sure that the oval neck of the bolt engages into the bolt hole of the housing.



5. **TIGHTEN NUTS:** Tighten nuts alternately and equally until the bolt pads meet and make metal-to-metal contact. Tighten nuts by another one quarter to one half turn to make sure the bolts and nuts are snug and secure. The use of a torque wrench is not required.



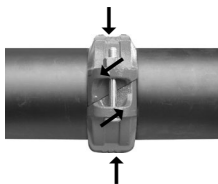

NOTE: As the coupling bolts are tightened, the angled bolt pads slide in opposite directions causing the coupling keys to tightly grip the pipe, while at the same time the pipe grooves are forced outward against the coupling keys. Bolt pads should always maintain metal-to-metal contact. Tighten nuts by another one quarter to one half turn to make sure the bolts and nuts are snug and secure. The use of a torque wrench is not required.

CAUTION

1. Uneven tightening of bolts and nuts may cause the gasket to be pinched, resulting in an immediate or delayed leak.
2. Never exceed torque stated in the table on page 36. Excessive tightening of nuts may cause bolt or joint failure.

Model C306 Reducing Coupling

Please read these instructions carefully before installation.

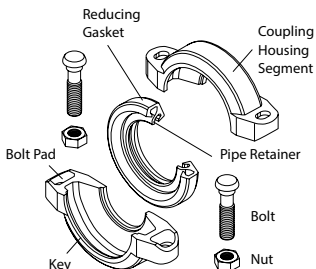

1. **INSPECT PIPE ENDS:** Make sure that two pipes prepared have the right O.D.'s and are properly grooved. For optimum sealing by the gasket, the exterior surface of the pipe ends must be free from any indentations, projections, roll marks or other harmful surface defects such as loose paint, scale, dirt, chips, grease and rust.

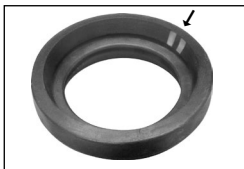

2. **CHECK GASKET:** Check the color code of the gasket and make sure that the gasket supplied is correct for the intended service. The standard factory supplied gasket for the copper series is a grade E-pw GapSeal gasket for potable water applications (double green stripe).

CAUTION

Do not use EPDM gaskets for hydrocarbons or petroleum services as this could result in a leak or joint failure.

 Refer to page 38 for additional information on gaskets.



3. **LUBRICATE GASKET:** To help insert pipe smoothly and mount couplings smoothly without pinching, apply a thin layer of Shurjoint Lubricant to the sealing lips of the gasket as well as to the exterior of the gasket. Other compatible lubricants may be used so long as they are not harmful to the gasket.

NOTE: For potable water applications, a NSF 61 approved lubricant must be used. If you are not using Shurjoint Lubricant, make sure the lubricant you are using is NSF 61 approved. In systems, subject to extreme hot or cold temperatures, the use of Shurjoint EHC silicone lube is recommended.



4. MOUNT GASKET ON LARGER PIPE: Mount the larger opening of the gasket over the larger pipe end.

NOTE: To aid a proper installation, always mount the larger pipe first.



5. INSERT SMALLER PIPE: Insert the smaller pipe into the gasket. A slight twisting motion of the pipe will make for easier assembly. The gasket shall neither overhang pipe end nor go into the groove of either pipe.

CAUTION

The Model C306 coupling must not be used with an end cap, as the end cap may be sucked into pipe when draining the system.

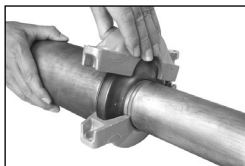

6. INSTALL COUPLING HALVES: Place the coupling halves over the gasket and make sure that the coupling keys are engaged into the grooves.

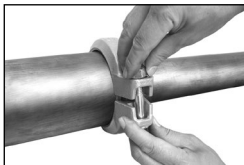

7. INSERT BOLT & NUT: Insert the bolts and apply the nuts hand tight. Make sure that the oval neck of the bolt engages into the bolt hole of the housing.

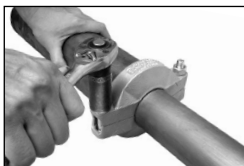

8. TIGHTEN NUTS: Tighten nuts alternately and equally until the bolt pads meet and make metal-to-metal contact. Tighten nuts by another one quarter to one half turn to make sure the bolts and nuts are snug and secure. The use of a torque wrench is not required.



CAUTION

1. Uneven tightening of bolts and nuts may cause the gasket to be pinched, resulting in an immediate or delayed leak.
2. Never exceed torque stated in the table on page 36. Excessive tightening of nuts may cause bolt or joint failure.

Model C307 Transition Coupling

Please read these instructions carefully before installation.

The Shurjoint Model C307 provides a direct transition from grooved IPS steel pipe to grooved CTS copper tubing.

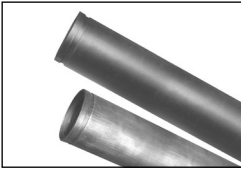
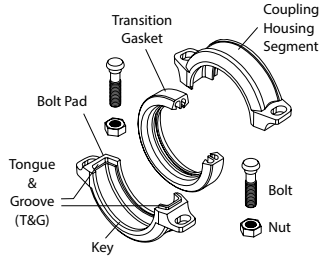

1. PREPARE PIPES: Make sure that the IPS steel pipe and copper tubing prepared have the right O.D.'s and are properly roll- or cut-grooved. For optimum sealing by the gasket, the exterior surface of the pipe ends must be free from any indentations, projections, roll marks or other harmful surface defects such as loose paint, scale, dirt, chips, grease and rust.



2. CHECK GASKET : Check the color code of the gasket and make sure that the gasket supplied is correct for the intended service. The standard factory supplied gasket for the copper series is a grade E-pw GapSeal gasket for potable water applications (double green stripe).



3. LUBRICATE GASKET: To help insert pipe smoothly and mount couplings smoothly without pinching, apply a thin layer of Shurjoint Lubricant to the sealing lips of the gasket and as well as to the exterior of the gasket. Other compatible lubricants may be used so long as they are not harmful to the gasket. In systems, subject to extreme hot or cold temperatures, the use of Shurjoint EHC silicone lube is recommended.

NOTE: For potable water applications, a NSF 61 approved lubricant must be used. If you are not using Shurjoint Lubricant, make sure the lubricant you are using is NSF 61 approved. In systems, subject to extreme hot or cold temperatures, the use of Shurjoint EHC silicone lube is recommended.

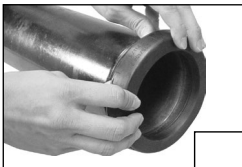

4. MOUNT GASKET ON IPS (STEEL) PIPE: Mount the larger opening of the gasket over the IPS steel pipe end.



NOTE: To aid a proper installation, always mount the larger pipe first.

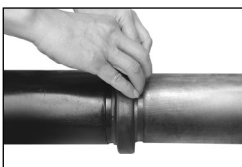

5. INSERT COPPER TUBING: Bring together and align the two pipes to mated. Insert the copper tubing into the gasket. A slight twisting motion will make for a easier assembly. The gasket shall neither overhang the pipe end or either groove on the pipes.

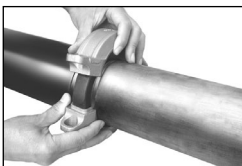

6. INSTALL COUPLING HALVES: Place the coupling halves over the gasket and make sure that the coupling keys are engaged into the grooves.

WARNING

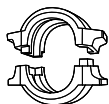

Yes



No

The Shurjoint Model C307 couplings feature a tongue and groove design and mechanism. Thus the couplings must always be installed so that tongue and groove mate properly. Attempting to install these couplings tongue to tongue or groove to groove will result in joint failure, property damage or serious injury.

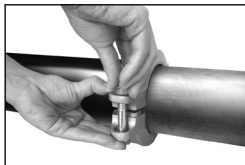

7. **INSTALL BOLT & NUT:** Insert the bolts and apply the nuts hand tight. Make sure that the oval neck of the bolt engages into the bolt hole of the housing.



8. **TIGHTEN NUTS:** Tighten nuts alternately and equally until the bolt pads meet and make metal-to-metal contact. Tighten nuts by another one quarter to one half turn to make sure the bolts and nuts are snug and secure. The use of a torque wrench is not required.



CAUTION

1. Uneven tightening of bolts and nuts may cause the gasket to be pinched, resulting in an immediate or delayed leak.
2. Never exceed torque stated in the table on page 36. Excessive tightening of nuts may cause bolt or joint failure.

Model C341 Flange Adapter

Please read these instructions carefully before installation.

The Shurjoint Model C341 flange adapter is drilled to ANSI Class 125/150.

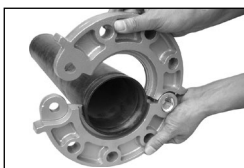
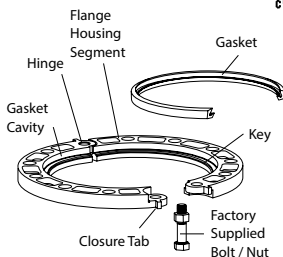

1. MOUNT HINGED FLANGE SEGMENTS: Fully open the Model C341 hinged flange segments. Place the flange segments around the groove of the pipe end and pull together until the mating bolt holes of the ends come to align.

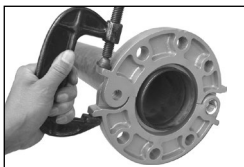

2. DRAW FLANGE SEGMENTS: Use a wrench, C-clamp or other similar tool to draw the closure tabs together until the mating holes are aligned.

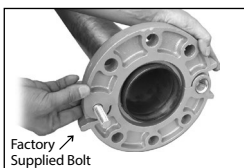

3. INSERT THE FACTORY SUPPLIED BOLT: Insert the Shurjoint factory supplied bolt through the mating hole making sure that the flange is fully engaged in the pipe grooves.



4. CHECK GASKET GRADE & LUBRICATE: Check the color code of the gasket and make sure that the gasket supplied is correct for the intended service. Then, apply a thin layer of Shurjoint Lubricant to the sealing lip of the gasket. In systems, subject to extreme hot or cold temperatures, the use of Shurjoint EHC silicone lube is recommended.

The standard factory supplied gasket is grade E-pw gasket, which is double green stripe coded and is acceptable for potable water services.

☞ Refer to page 38 for additional information on gaskets.

⚠ CAUTION

Do not use EPDM gaskets for hydrocarbons or petroleum services as this could result in a leak or joint failure.



5. **INSTALL GASKET:** Place the gasket into the cavity between the pipe O.D., and flange recess. Make sure that the bottom of the gasket (the marking side) is positioned and seated against the bottom of the flange recess.

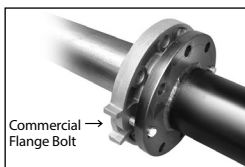

6. **MATE ADJOINING FLANGE:** Insert commercial flange bolt in the hinge hole (opposite side of the factory supplied bolt) and tighten the nuts of the commercial flange bolt and the factory supplied bolt.

⚠ CAUTION

Use of any bolts other than those supplied with the flange adapter could result in a leak or joint failure.

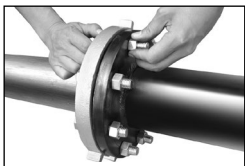

7. **ADD BOLTS:** Add the remaining commercial flange bolts and apply the nuts hand tight. All the bolts shall be inserted from the same direction.

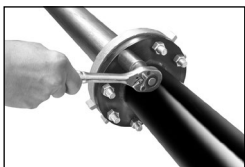

8. **TIGHTEN NUTS:** Tighten nuts alternately in the sequence of diagonally opposite pairs until the flange faces meet and make metal-to-metal contact. Use a torque wrench so that all the nuts are tightened with the same torque value. See below table for required torque values.



NOTE: When joining the C341 to carbon steel flanges it is recommended that a dielectric flange kit be used. Use of a Model C49 sandwich plate may be necessary to insure a proper seal with dielectric flange gaskets.

Required Bolt Torque: The table below provides the standard torque values for proper assembly of Shurjoint flange adapter. Use a torque wrench so that all the nuts are tightened equally with a same torque value.

These torque values are not the maximum values and the bolts can be torqued for above the values listed. Attaining maximum torque value is not necessary as the Shurjoint flange adapter are sealed with elastic (rubber) gaskets, which require a much lower torque than that of metallic gaskets.

Shurjoint Flange Adapter ANSI Class 125/150
Model C341

Nom. Size inch	Bolt		Required Torque	
	Size inch	No.	Lbs-Ft	Nm
2	$\frac{5}{8}$	4	110 ~ 140	149 ~ 190
2½	$\frac{5}{8}$	4	110 ~ 140	149 ~ 190
3	$\frac{5}{8}$	4	110 ~ 140	149 ~ 190
4	$\frac{5}{8}$	4	110 ~ 140	149 ~ 190
5	$\frac{3}{4}$	8	220 ~ 250	298 ~ 339
6	$\frac{3}{4}$	8	220 ~ 250	298 ~ 339

Model C723 Bronze Mechanical Tee

Please read these instructions carefully before installation.

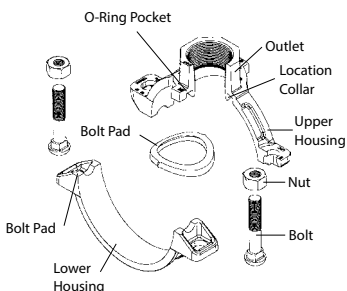

1. HOLE CUT: Determine the proper location on the centerline of the tubing. Use the proper hole saw as specified for cutting the hole. Proper hole size is essential for proper sealing and performance of this component.

Hole Size for Mechanical Tee Model C723

Hole Dimension:

Branch Size in / mm	Hole Dimensions		Surface Preparation "A" in / mm
	Hole Saw Size in / mm	Max. Dia. Allowed in / mm	
1/2, 3/4, 1	1 3/16	1 1/4	3 1/2
1 1/2, 20, 25	30	32	89
1 1/4	1 3/4	1 7/8	4
32	45	47	102

* Please refer to page 83.



2. REMOVE BURRS: Remove any burrs and clean the pipe surface within 5/8" (16 mm) of the hole. This surface must be clean, smooth and free of any projections, indentations that could affect the sealing of the o-ring gasket.

⚠ CAUTION

The hole must be cleanly cut and shall have a smooth edge. Never use a hand torch for cutting a hole as this could affect proper sealing.



3. CHECK THE O-RING GASKET AND LUBRICATE: Check the color code of the o-ring gasket and make sure that the o-ring gasket supplied is correct for the intended service. Then apply a thin layer of Shurjoint Lubricant to the o-ring gasket. In systems, subject to extreme hot or cold temperatures, the use of Shurjoint EHC silicone lube is recommended.

The standard factory supplied o-ring gasket is grade E-pw EPDM (color code – double green stripe) and is basically good for potable water services.

☞ Refer to page 38 for additional information on gaskets.



4. INSERT GASKET: Insert the o-ring gasket into the gasket pocket of the housing.



5. PREPARE TO ASSEMBLE: Assemble the coupling housings loosely, leaving one nut and bolt off to allow a “swing-over” installation.



6. POSITION THE UPPER HOUSING: Place the upper housing on the pipe so that the locating collar engages fully and properly in the hole. Then apply the lower housing from the opposite side of the pipe.



7. INSERT BOLT & NUT: Insert the remaining bolt & nut and apply both nuts hand tight. Make sure the oval neck of the bolts fully engages into the bolt hole of the housing.



8. CHECK LOCATING COLLAR: Double check to ensure the locating collar is properly seated in the hole. This may be checked by slightly rocking the upper housing in the hole. Also make sure that the oval neck of the bolts is fully engaged into the bolt holes of the housing.



9. TIGHTEN NUTS: Tighten nuts alternately and equally until the outlet housing comes to contact the outer surface of the pipe, metal-to-metal contact. Gaps between bolt pads are normal but the gaps shall be equal on both sides. Use a torque wrench and tighten the nuts to an approximate torque value of 5-9 Lbs-Ft (7-12 Nm).

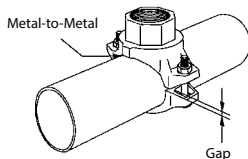

⚠ CAUTION

Increased torque does not enhance the sealing capacity of the component. Excessive tightening of nuts may cause a bolt or joint failure, and / or pipe deformation and cause leaking. To help avoid excessive torque use a wrench with a maximum length of 8" (200 mm).

PLAIN-END IPS PIPING SYSTEM

Model 79 "Wildcat" Coupling

Please read these instructions carefully before installation.

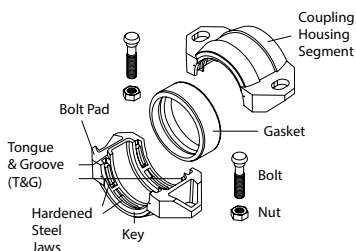

The Shurjoint Model 79 "WILDCAT" plain end coupling is designed to mechanically join plain-end or beveled end carbon steel pipe. No grooving is required. The Model 79 coupling is recommended for use on carbon steel pipe with a hardness less than HB150, not recommended for stainless steel, plastic, HDPE cast iron or other brittle pipe.



1. **MARKING:** Use a marking pen or other marking tool and measuring tape to place marks on each pipe end, 1" from each end. This mark will be used for reference in centering the gasket during installation. A minimum of 4 marks equally spaced around the pipe are recommended.

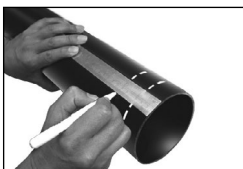

2. Use a measuring tape and a marking pen or other marking tool to mark an additional mark on the pipe ends at the measurement listed in the column "Coupling Centering Marks" of the Table 1 on page 126. This mark will be used for visual inspection to make sure the pipe is inserted properly in the coupling. Make these marks parallel to the marks from the gasket centering reference marks.



3. **CHECK GASKET:** Check the color code of the gasket and make sure that the gasket supplied is correct for the intended service. The standard factory supplied gasket is grade E EPDM, which is green stripe coded and is basically good for water services.

☞ Refer to page 38 for additional information on gaskets.

⚠ CAUTION

Do not use EPDM gaskets for hydrocarbons or petroleum services as this could result in a leak or joint failure.



4. **LUBRICATE GASKET:** To help insert pipe smoothly and mount couplings smoothly without pinching, apply a thin layer of Shurjoint Lubricant to the sealing lips of the gasket and as well as to the exterior of the gasket. Other compatible lubricants may be used so long as they are not harmful to the gasket. In systems, subject to extreme hot or cold temperatures, the use of Shurjoint EHC silicone lube is recommended.



5. **INSTALL GASKET:** Place a gasket over the pipe ends and center the gasket in between the first set inner marks. The pipe ends should always be butted against each other.



6. **MOUNT HOUSINGS:** Place the housings over the gasket, ensuring the gasket stay centered between the first set inner marks made on the pipe ends and the housings are properly centered between the second set outer marks. Also make sure that housing tongue and groove (T&G) mate correctly.

⚠ CAUTION

In order to avoid injuries from the sharp machined teeth, wear gloves when handling.



7. **INSERT BOLTS & NUTS:** Insert the bolts and apply nuts hand tight. Make sure that the oval neck of the bolt engages into the bolt hole of the housing.





8. **TIGHTEN NUTS:** Tighten nuts alternately and equally, using a torque wrench, until the required torque value is achieved. Insufficient torque can lead to pipe separation, which can cause injuries and / or property damage. For required torque values, see table below.

Table 1
Coupling Centering Mark & Minimum Required Torque for Model 79
Wildcat Coupling

Size in / mm	Coupling Centering Mark in / mm	Couplings Bolts		
		Q'ty	Bolt Size in	Required Bolt Torque Lbs-Ft / Nm
1	1.50	2	½ x 2¾	110
25	40			150
1½	1.50	2	½ x 2¾	110
40	40			150
2	1.75	2	⅝ x 3½	150
50	45			200
2½	1.75	2	⅝ x 3½	150
65	45			200
3	1.75	2	¾ x 4¾	200
80	45			270
4	2.00	2	¾ x 4¾	200
100	50			270
5	2.00	2	⅞ x 6½	250
125	50			340
6	2.25	2	⅞ x 6½	250
150	55			340
8	2.50	4	¾ x 4¾	200
200	65			270
10	2.50	4	⅞ x 6½	300
250	65			400
12	2.50	4	1 x 6½	350
300	65			470
14	2.75	4	1 x 6½	350
350	70			470
16	2.75	4	1 x 6½	350
400	70			470

 **CAUTION**

1. Uneven tightening of bolts and nuts may cause the gasket to be pinched, resulting in an immediate or delayed leak.
2. Excessive tightening of nuts may cause bolt or joint failure.

PLAIN-END HDPE PIPING SYSTEM

The Shurjoint HDPE series of piping components are designed to provide a fast and easy way to mechanically join HDPE (high density polyethylene) pipe. These components are designed to join HDPE pipe and fittings conforming to ASTM D2447, D3035 or F714 (metric sizes to ISO 161/1, DIN 8074 and AS 8074), at ambient temperatures with wall thickness from SDR 32.5 to 7.3. This method eliminates the need for costly heat fusion equipment, solvent joining and/or complicated adapters. Shurjoint HDPE piping components are rated to the same pressure as that of the HDPE pipe they are used in conjunction with.

Working Pressure: Since the physical strength of the Shurjoint HDPE couplings joint is much greater than HDPE pipe, working pressures are governed by the working pressures of the HDPE pipe, which vary depending on pipe composition, wall thickness and service temperature.

HDPE Pipe

This chart shows the allowed dimensional tolerances of HDPE (high density polyethylene) rigid pipe with SDR 20 at +70°F (+21°C).

HDPE PIPE DIMENSIONS

Pipe Size/Tolerances – Imperial (ANSI/NPS)

Nominal Size in / mm	Pipe O.D. in / mm	Tol. in / mm	Max. Out of Round Tol. in / mm	Nominal Size in / mm	Pipe O.D. in / mm	Tol. in / mm	Max. Out of Round Tol. in / mm
2	2.375	0.016	0.040	10	10.750	0.048	0.075
50	60.3	± 0.406	± 1.016	250	273.0	± 1.219	± 1.905
3	3.500	0.016	0.040	12	12.750	0.057	0.075
80	88.9	± 0.406	± 1.016	300	323.9	± 1.448	± 1.905
4	4.500	0.020	0.040	14	14.000	0.063	0.075
100	114.3	± 0.508	± 1.016	350	355.6	± 1.600	± 1.905
5	5.563	0.025	0.050	16	16.000	0.072	0.075
125	141.3	± 0.635	± 1.270	400	406.4	± 1.830	± 1.905
6	6.625	0.030	0.050	18	18.000	0.081	0.075
150	168.3	± 0.762	± 1.270	450	457.0	± 2.060	± 1.905
8	8.625	0.039	0.075	20	20.000	0.090	0.07
200	219.1	± 0.990	1.905	500	508.0	± 2.290	± 1.905

Pipe Size/Tolerance – Metric Sizes
(DIN and Others)

Pipe O.D. Min. mm	Pipe O.D. Max.* mm
50	50.5
63	63.6
75	75.7
90	90.9
110	111.0
160	161.5
180	181.7
200	201.8
225	226.4
250	252.3
280	281.7
315	317.9
355	357.2
400	402.4
450	452.7
500	504.0

*Tolerances at ambient temperatures for pipe with SDR of 20 or lower.

NOTE: The Shurjoint HDPE couplings are not intended for use on PVC or other material.

Model H305 HDPE Coupling

Please read these instructions carefully before installation.

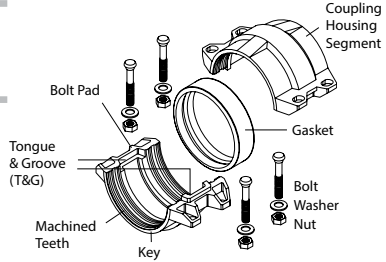

The Shurjoint Model H305 HDPE couplings feature four bolt housings and a series of sharply machined teeth which positively grip the pipe as the coupling bolts and nuts are tightened.

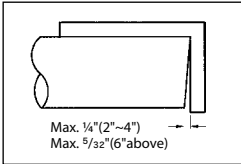

1. **SQUARE CUT HDPE PIPE:** HDPE pipe must be cut square. The maximum allowed tolerances are 1/8" (3.2 mm) on HDPE pipe sizes 2" to 4" and 5/32" (4.0 mm) on 6" and larger sizes. Make sure that the pipe end, within 1" from the end, is clean and free from indentations, projections, scratches or other harmful surface defects such as scale, chips, grease, etc.



2. **MARKING:** Use a marking pen or other marking tool and measuring tape to mark the pipe ends at the measurement listed in Table 2 & 2a. This mark will be used for reference in centering the gasket during installation. A minimum of 4 marks equally spaced around the pipe are recommended.



3. Use a marking pen or other marking tool and measuring tape to mark an additional mark on the pipe ends at the measurement listed in the "Coupling Centering Marks" column of the below table 2 & 2a. This mark will be used for visual inspection to make sure the pipe is inserted properly in the coupling. Make these marks parallel to the marks from the gasket centering reference marks.

Table 2 H305 – IPS Size

Nominal Size in / mm	Gasket Centering Reference Marks in / mm	Coupling Centering Reference Marks in / mm
2	7/8	2 ⁵ / ₁₆
50	22	58
3	7/8	2 ⁵ / ₁₆
80	22	58
4	7/8	3
100	22	75
6	1	3
150	25	75
8	1 ¹ / ₁₆	3 ¹ / ₁₆
200	26	77
10	1 ¹ / ₁₆	3 ¹ / ₄
250	26	83
12	1 ¹ / ₁₆	3 ⁹ / ₁₆
300	26	90
14	1 ⁷ / ₁₆	5 ¹ / ₈
350	36	129
16	1 ⁷ / ₁₆	5 ¹ / ₈
400	36	129
18	1 ⁷ / ₁₆	5 ¹ / ₈
450	36	129
20	1 ³ / ₈	5 ¹ / ₈
500	40	129

Table 2a H305 – Metric Size

Nominal Size mm	Gasket Centering Reference Marks mm	Coupling Centering Reference Marks mm
50	22	53
63	22	53
75	22	53
90	22	53
110	22	56
160	25	59
180	25	59
200	26	64
225	26	64
250	26	67
280	26	67
315	26	67
355	37	129
400	37	129
450	37	129
500	37	131

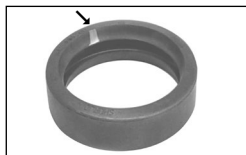

4. CHECK GASKET: Check the color code of the gasket and make sure that the gasket supplied is correct for the intended service.

The standard factory supplied gasket is grade E EPDM, which is green stripe coded and is basically good for water services.



5. INSTALL GASKET: Place a gasket over the pipe ends and center the gasket in between the first set marks. The pipe ends should always be butted against each other.

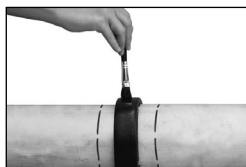

6. LUBRICATE THE GASKET: Lubricate the back of the gasket with a silicone based lubricant such as the Shurjoint EHC Lube. Corn oil, soybean oil and glycerin and silicone can also be used on HDPE piping system.

⚠ WARNING

Do not use the Shurjoint standard Lubricant, which is designed for steel pipe use. Do not use hydrocarbon based oils, grease or soap based solutions as this could lead joint failure.



7. MOUNT HOUSINGS: Place the housings over the gasket, ensure the gasket stays centered between the first set marks made on the pipe ends and the housings are properly centered between the second set marks. Also make sure that housing tongue and groove (T&G) mate correctly.

⚠ CAUTION

In order to avoid injuries from the sharp machined teeth, wear gloves when handling.

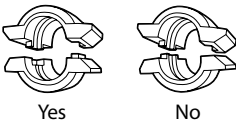
⚠ WARNING

The Shurjoint Model H305 couplings feature a tongue and groove design and mechanism. Thus the couplings must always be installed so that tongue and groove mate properly. Attempting to install these couplings tongue to tongue or groove to groove will result in joint failure, property damage or serious injury.



8. INSERT BOLTS & NUTS: Insert the bolts. Install a washer onto the end of each bolt. Thread a nut onto each bolt and apply nuts hand tight. Make sure that the oval neck of the bolt engages into the bolt hole of the housing.

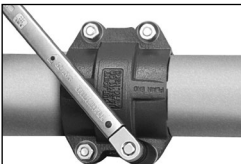

9. TIGHTEN NUTS: Tighten nuts alternately and equally until the bolt pads meet and make metal-to-metal contact. Repeated alternate tightening will reduce tightening torque considerably. Tighten nuts by another one quarter to one half turn to make sure the bolts and nuts are snug and secure. The use of a torque wrench is not required.



NOTE: Large Diameter HDPE Coupling: The 14" (355.6 mm) and larger Model H305 HDPE Coupling contain hex bolts, washers & nuts that require special instructions for tightening. Refer to the below steps 9 - 11 for the proper tightening sequence.



9. INSERT BOLTS & WASHERS: Insert a hex bolt and a washer into each side of a bolt hole in the housings. Make sure the head of each hex bolt & washer engages with the recess in the housing.



10. INSERT NUTS: Thread a nut onto the end of each hex bolt until the washer contacts the coupling housing.



11. TIGHTEN NUTS: Tighten nuts alternately and equally until the bolt pads meet and make metal-to-metal contact. Tighten nuts by another one quarter to one half turn to make sure the bolts and nuts are snug and secure. Inspect the finished assembly to make sure the washers are engaged in the recesses of bolt pads in the coupling housings.



⚠ CAUTION

1. Uneven tightening of bolts and nuts may cause the gasket to be pinched, resulting in an immediate or delayed leak.
2. Never exceed torque stated in the table on page 36. Excessive tightening of nuts may cause bolt or joint failure.

Model H307 HDPE Transition Coupling

Please read these instructions carefully before installation.

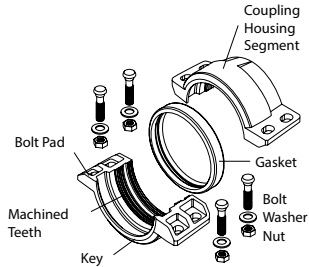

The Shurjoint Model H307 transition coupling provides for a direct transition from HDPE pipe to IPS steel pipe of the same outside diameter. The Model H307 transition coupling must be installed with its machined teeth side on the HDPE pipe and key section side on the grooved steel pipe.

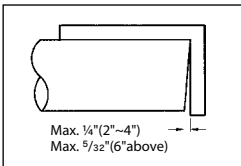

1. **SQUARE CUT HDPE PIPE:** HDPE pipe must be cut square. The maximum allowed tolerances are $\frac{1}{8}$ " (3.2 mm) on HDPE pipe sizes 2" to 4" and $\frac{5}{32}$ " (4.0 mm) on 6" and larger sizes. Make sure that the pipe end, within 1" from the end, is clean and free from indentations, projections, scratches or other harmful surface defects such as scale, chips, grease, etc.



2. Groove the IPS steel pipe to the current Shurjoint specification

3. **MARKING:** Use a marking pen or other marking tool and measuring tape to place the marks on the HDPE pipe end, refer to Table 3 & 3a for marking location from the HDPE pipe end. A minimum of 4 marks equally spaced around the pipe are recommended. This mark will be used for visual inspection to make sure the pipe is inserted properly in the coupling.

Table 3 H307 IPS size

Nominal Size in / mm	Actual HDPE Pipe O.D. in / mm	Mark Location from the HDPE pipe end in / mm
2	2.375	2½
50	60.3	54
3	3.500	2½
80	88.9	54
4	4.500	2¾
100	114.3	69
6	6.625	2¾
150	168.3	69
8	8.625	3
200	219.1	75
10	10.750	3¾
200	273.0	94
12	12.750	3¾
300	323.9	97

Table 3a H307 ISO Metric Size

Nominal Size mm	Mark Location from the HDPE pipe end mm
63	50
75	50
90	50
110	50
160	50
200	53
250	64
315	64



4. CHECK GASKET: Check the color code of the gasket and make sure that the gasket supplied is correct for the intended service.

The standard factory supplied gasket is grade E EPDM, which is green stripe coded and is basically good for water services.

☞ Refer to page 38 for additional information on gaskets.

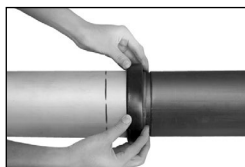

5. INSTALL GASKET: Place a gasket over the pipe ends and center the gasket in between the mark on HDPE pipe and the groove of the IPS steel pipe. The pipe ends are preferably to be butted against each other or with a controlled space (see note).

Note: The maximum allowed space between HDPE pipe and steel pipe is ¼" (6.3 mm) on pipe 2" to 4" and 5/16" (7.9 mm) on pipe 6" and larger.



6. LUBRICATE THE GASKET: Lubricate the back of the gasket with a silicone based lubricant such as the Shurjoint EHC Lube. Corn oil, soybean oil and glycerin can also be used on HDPE piping system.

⚠ WARNING

Do not use the Shurjoint standard Lubricant, which is designed for steel pipe use. Do not use hydrocarbon based oils, grease or soap based solutions as this could lead joint failure.



7. MOUNT HOUSING: Place the housings over the gasket, ensuring the gasket stay centered between the marks made on the HDPE pipe and the groove of the IPS steel pipe.

⚠ CAUTION

In order to avoid injuries from the sharp machined teeth, wear gloves when handling.



8. INSERT BOLTS & NUTS: Insert the bolts. Install a washer onto the end of each bolt. Thread a nut onto each bolt and apply nuts hand tight. Make sure that the oval neck of the bolt engages into the bolt hole of the housing.



9. TIGHTEN NUTS: Tighten nuts alternately and equally until the bolt pads meet and make metal-to-metal contact. Repeated alternate tightening will reduce tightening torque considerably. Tighten nuts by another one quarter to one half turn to make sure the bolts and nuts are snug and contact. The use of a torque wrench is not required.

**⚠ CAUTION**

1. Uneven tightening of bolts and nuts may cause the gasket to be pinched, resulting in an immediate or delayed leak.
2. Never exceed torque stated in the table on page 36. Excessive tightening of nuts may cause bolt or joint failure.

Model H312 HDPE Flange Adapter

Please read these instructions carefully before installation.

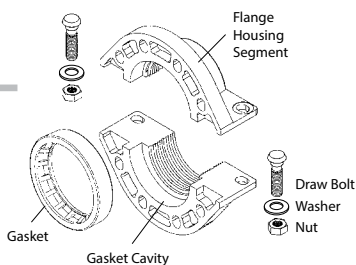

The Shurjoint Model H312 HDPE flange adapter provides a direct transition from HDPE pipe to ANSI Class 125/150 flanged valves or other components.

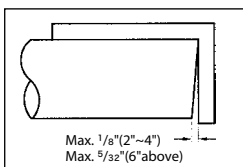

1. **SQUARE CUT HDPE PIPE:** HDPE pipe must be cut square. The maximum allowed tolerances are $\frac{1}{8}$ " (3.2 mm) on HDPE pipe sizes 2" to 4" and $\frac{5}{32}$ " (4.0 mm) on 6" and larger sizes. Make sure that the pipe end, within 1" from the end, is clean and free from indentations, projections, scratches or other harmful surface defects such as scale, chips, grease, etc.



2. **MOUNT HOUSING:** Place the flange housings over HDPE pipe. The flange must be assembled with its machined teeth on the HDPE pipe. The gasket cavity must face the pipe end. Insert the draw bolts into the flange adapter housings. Install a washer onto the end of each bolt. Thread a nut loosely onto the end of each draw bolt.

CAUTION

In order to avoid injuries from the sharp machined teeth, wear gloves when handling.

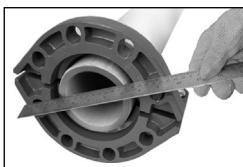

3. **FLUSH FACE:** The HDPE pipe end must be flush with the flange face. Use a ruler or other straight edge tool to verify this and, if not flush as intended, make the necessary adjustment.



4. **TIGHTEN DRAW BOLTS:** Tighten the draw bolts and nuts alternately and equally until the housing bolt pads meet forming metal-to-metal contact. Repeated alternate tightening will reduce tightening torque considerably.



5. **CHECK GASKET AND LUBRICATE:** Check the color code of the gasket and make sure that the gasket supplied is correct for the intended service. Lubricate the back of the gasket with a silicone based lubricant, such as the Shurjoint EHC. Corn oil, soybean oil and glycerin can also be used on HDPE piping system.

⚠ WARNING



Do not use the Shurjoint standard Lubricant, which is designed for steel pipe use. Do not use hydrocarbon based oils, grease or soap based solutions as this could lead joint failure.

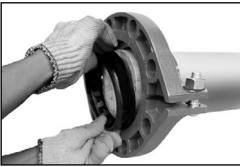

6. **INSTALL GASKET:** Mount the gasket into the cavity between the pipe O.D. and flange recess. Make sure that the bottom of the gasket (the marking side) is positioned and seated against the bottom of the flange recess.

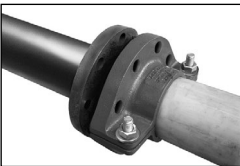

7. **MATE ADJOINING FLANGE:** Bring the adjoining flange face to face with the Model H312 flange.



8. **ADD BOLTS:** Add flange bolts and apply nuts hand tight. All the bolts shall be inserted from the same direction. Make sure that the oval neck of the bolt engages into the bolt hole of the housing.

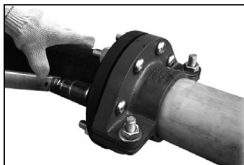

9. TIGHTEN NUTS: Tighten all nuts evenly as with a regular flange assembly, until faces contact firmly. Apply the recommended flange joint torque evenly to all the bolts. See Table 4 for the required torque.

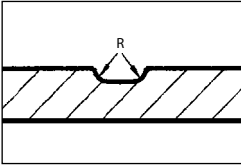

Table 4 Required torque for H312

Nom. Size inch	Bolt		Required Torque	
	Size inch	No.	Lbs-Ft	Nm
3	$\frac{5}{8}$	2	110 ~ 140	149 ~ 190
4	$\frac{5}{8}$	2	110 ~ 140	149 ~ 190
6	$\frac{5}{8}$	2	110 ~ 140	149 ~ 190
8	$\frac{3}{4}$	2	220 ~ 250	298 ~ 339
10	$\frac{3}{4}$	4	220 ~ 250	298 ~ 339
12	$\frac{3}{4}$	4	220 ~ 250	298 ~ 339

AWWA DUCTILE IRON SERIES

How to Install Gaskets - Preliminary Steps -



1. **RADIUS CUT GROOVE:** Cut grooves to be processed on ductile iron (or gray iron pipe) must have a radius at the corners of the groove as specified in ANSI/AWWA C606 (latest edition).

☞ Refer to Table page 34 for radius cut grooves.

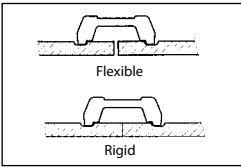

2. **RIGID OR FLEXIBLE:** There are two different radius grooves, one for flexible joints and one for rigid joints. The same Shurjoint AWWA couplings are used for both types of grooves. Standard Shurjoint AWWA fittings are manufactured with a rigid cut groove.



3. **INSPECT PIPE ENDS:** The lip-sealing surface of the pipe OD, (A) dimension on Page 35, must be free from deep scores, indentations, projections, and cracks to provide a leak tight gasket sealing surface. Other harmful defects such as loose paint, dirt, scale, grease and rust must also be removed. The peened surfaces of Ductile Iron Pipe are not always consistent and in some cases, may require rework to provide a leak free sealing surface. (see CSA B242 5.9 or AWWA C606).



4. **CHECK GASKET GRADE & LUBRICATE:** Check the color code of the gasket and make sure that the gasket supplied is correct for the intended service. The standard factory supplied gasket is grade M, Halogenated Butyl gasket, which is brown color coded and is basically good for water services. Apply a thin layer of Shurjoint Lubricant to the sealing lips of the gasket and as well as to the exterior of the gasket. Other compatible lubricants may be used so long as they are not harmful to the gasket.

☞ Refer to page 38 for additional information on gaskets.



5. **INSTALL GASKET:** Install the gasket over one end of the pipe so that the pipe end is exposed. No part of the gasket should overhang this end of the pipe.



6. **BRING MATING PIPE TOGETHER:** Bring the mating pipe together and align the two pipe ends, slide back the gasket into position over the two pipe ends and center between the grooves. No part of the gasket should protrude into the groove on either pipe.



NOTE: For larger sizes you may turn the gasket inside out before mounting on the pipe end. Lubricate the gasket and slide over the pipe end and flip back the gasket into position.

NOTE: Flexible Systems: For proper expansion and contraction, when using flexible pipe grooves, couplings must be installed with proper anchors, bracing, and guides to accommodate for thermal changes. Proper spacing will need to be set at time of installation to account for pipe movement due to future temperature changes.

NOTE: Hanger Spacing: Support of ductile iron piping systems must eliminate stress on piping joints and other components, and allow for pipe movement where required. The table below is a **SUGGESTED** maximum span for horizontal pipe runs that convey water or similar liquids. System designers must also consider special requirements for concentrated loads and areas where critical calculation have been made. Shurjoint Piping Products is not responsible for system designs.

Flexible Systems		Rigid Systems	
Size	Suggested Maximum Span	Size	Suggested Maximum Span
in./mm	Feet / Meters	in./mm	Feet / Meters
3-4	12	3-4	15
(80-100)	(3.7)	(80-100)	(4.6)
6-8	14	6-12	20
(150-200)	(4.3)	(150-300)	(6.1)
10-12	16		
(250-300)	(4.9)		

Note: Piping Systems must have at least one support per pipe length.



Model A505 Coupling

Please read these instructions carefully before installation.

1. Refer to page 139 for preliminary steps 1,2,3,4,5 & 6.

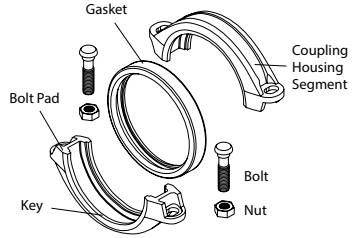

2. APPLY COUPLING HOUSINGS: Place the housings over the gasket and ensure the coupling keys are engaged into the grooves.

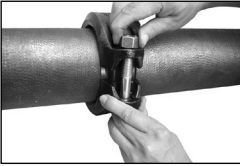

3. INSERT BOLT & NUT: Insert bolts and apply nuts hand tight. Make sure that the oval neck of the bolt engages into the bolt hole of the housing.



4. TIGHTEN NUTS: Tighten nuts alternately and equally until the bolt pads meet and make metal-to-metal contact. Tighten nuts by another one quarter to one half turn to make sure the bolts and nuts are snug and secure. The use of a torque wrench is not required.



⚠ CAUTION

1. Uneven tightening of bolts and nuts may cause the gasket to be pinched, resulting in an immediate or delayed leak.
2. Never exceed torque stated in the table on page 36. Excessive tightening of nuts may cause bolt or joint failure.

Model A507 Transition Coupling

Please read these instructions carefully before installation.

The Shurjoint Model A507 provides a direct transition from grooved IPS steel pipe to grooved AWWA ductile iron (or cast iron) pipe.

1. Refer to page 139 for preliminary steps 1,2,3,4,5 & 6.

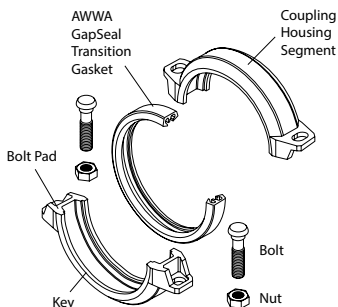

2. **INSTALL GASKET:** Place the larger (AWWA side) opening of the gasket over the larger (AWWA) pipe end until the pipe end reaches and butts against the pipe stop of the gasket.

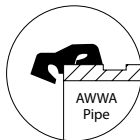

⚠ CAUTION

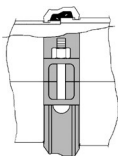

The difference of pipe O.D.'s between AWWA pipe (larger side) and IPS pipe (smaller side) is not always conspicuous. Special attention should be paid when mounting the gasket to ensure proper assembly.



3. **JOIN THE PIPE ENDS:** Use a slight twisting motion of the pipe and align the two pipe ends to be joined, then slide the gasket into position over the two pipe ends and center between the grooves. No part of the gasket should protrude into the groove on either pipe.



4. **APPLY COUPLING HOUSINGS:** Place the housings over the gasket and make sure the coupling keys are engaged into the grooves.

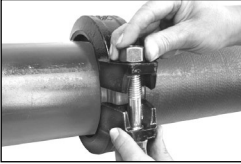

5. **INSERT BOLT & NUT:** Insert bolts and apply nuts hand tight. Make sure that the oval neck of the bolt engages into the bolt hole of the housing.



6. **TIGHTEN NUTS:** Tighten nuts alternately and equally until the bolt pads meet and make metal-to-metal contact. Tighten nuts by another one quarter to one half turn to make sure the bolts and nuts are snug and secure. The use of a torque wrench is not required.



⚠ CAUTION

1. Uneven tightening of bolts and nuts may cause the gasket to be pinched, resulting in an immediate or delayed leak.
2. Never exceed torque stated in the table on page 36. Excessive tightening of nuts may cause bolt or joint failure.

Model A512* Flange Adapter (2" - 12")

Please read these instructions carefully before installation.

The Model A512 flange adapter is designed for AWWA ductile iron pipe use only, not applicable to any other pipe.

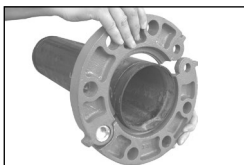
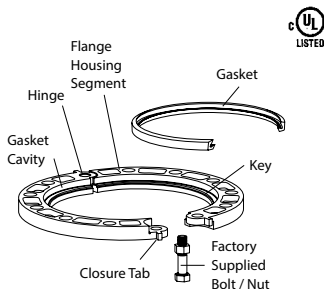

1. MOUNT HINGED FLANGE SEGMENTS: Fully open the Model A512 hinged flange segments. Place the flange segments around the groove of the pipe end and pull together until the mating bolt holes of the ends come to align.



2. DRAW FLANGE SEGMENTS: Use a wrench, C-clamp or other similar tool to draw the closure tabs together until the mating holes are aligned.

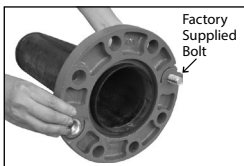

3. INSERT THE FACTORY SUPPLIED BOLT: Insert the Shurjoint factory supplied bolt through the mating hole making sure that the flange is fully engaged in the pipe grooves.

CAUTION

Use of any bolt other than the one supplied with the flange adapter could result in a leak or joint failure.

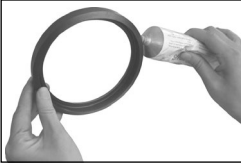

4. CHECK GASKET GRADE & LUBRICATE: Check the color code of the gasket and make sure that the gasket supplied is correct for the intended service. Then, apply a thin layer of Shurjoint Lubricant to the sealing lip of the gasket.

The standard factory supplied gasket is grade M Halogenated Butyl gasket, which is brown stripe coded and is basically good for water services.

☞ Refer to page 38 for additional information on gaskets.



5. INSTALL GASKET: Place the gasket into the cavity between the pipe O.D., and flange recess. Make sure that the bottom of the gasket (the marking side) is positioned and seated against the bottom of the flange recess.

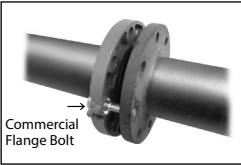

6. MATE ADJOINING FLANGE: Insert commercial flange bolt in the hinge hole (opposite side the factory supplied bolt) and tighten the nuts of the commercial flange bolt and the factory supplied bolt.

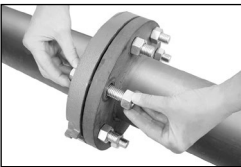

7. ADD BOLTS: Add the remaining commercial flange bolts and apply nuts hand tight. All the bolts shall be inserted from the same direction.



8. TIGHTEN NUTS: Tighten nuts alternately in the sequence of diagonally opposite pairs until the flange faces meet and make metal-to-metal contact. Use a torque wrench so that all the nuts are tightened with the same torque value. See page 148 Table 3 for required torque values.

* A512 in size 12" is not cUL listed.



Model A512 Flange Adapter (14" - 24")

Please read these instructions carefully before installation.

The Shurjoint Model A512 flange adapter is drilled to ANSI Class 125/150.

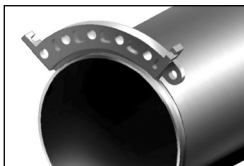
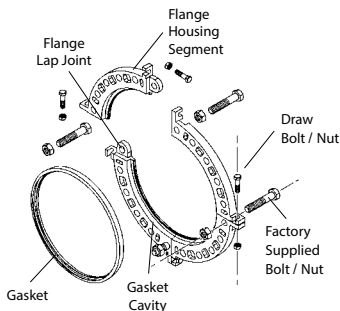

1. ASSEMBLE SEGMENTS: Place the first flange segment onto the pipe making sure that the key is engaged in the groove. As an option, you may put two flange segments together before mounting them onto the pipe.

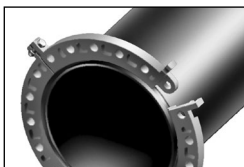

2. ADD OTHER SEGMENTS: Add other flange segments one by one and assemble them with draw bolts. Do not tighten the draw bolt tightly until the final flange segment is brought together and flange alignment is finished.

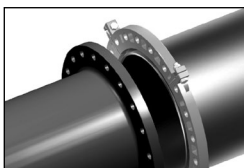

3. ALIGN FLANGE: Rotate the assembled flange so that the bolt holes are aligned to the bolt holes of the mating flange. When necessary, loosen draw bolts to allow easy rotation. Then tighten the draw bolts uniformly to form a complete flange.

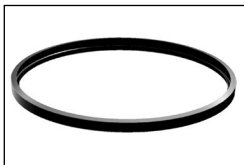

4. CHECK GASKET GRADE & LUBRICATE: Check the color code of the gasket and make sure that the gasket supplied is correct for the intended service. Then, apply a thin layer of Shurjoint Lubricant to the sealing lip of the gasket.

The standard factory supplied gasket is grade M Halogenated Butyl gasket, which is brown stripe coded and is basically good for water services.

☞ Refer to page 38 for additional information on gaskets.

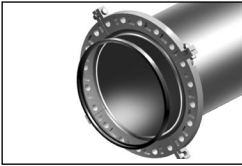

5. **INSTALL GASKET:** Place the gasket into the gasket cavity between the pipe O.D., and flange recess. Make sure that the bottom of the gasket (the marking side) is positioned and seated against the bottom of the gasket pocket.

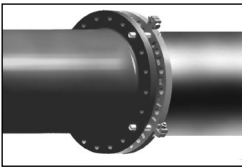

6. **INSERT FACTORY SUPPLIED BOLTS:** Bring the adjoining flange face to face with the Model A512 flange and insert the four factory supplied bolts through the four bolt holes at the flange lap joints.

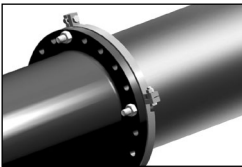

7. **MATE ADJOINING FLANGE:** Apply four nuts on the four factory supplied bolts and provisionally tighten them.



8. **TIGHTEN NUTS:** Tighten nuts alternately in the sequence of diagonally opposite pairs until the flange faces meet and make metal-to-metal contact. Use a torque wrench so that all the nuts are tightened with the same torque value. See below table for required torque values.



Required Bolt Torque: The table below provides the standard torque values for proper assembly of Shurjoint flange adapters. Use a torque wrench so that all the nuts are tightened equally with a same torque value.

These torque values are not the maximum values and the bolts can be torqued for above the values listed. Attaining maximum torque value is not necessary as the Shurjoint flange adapters are sealed with elastic (rubber) gaskets, which require a much lower torque than that of metallic gaskets.

Shurjoint Flange Adapter ANSI Class 125/150

Model A512

Nom. Size inch	Bolt		Required Torque	
	Size inch	No.	Lbs-Ft	Nm
2	$\frac{5}{8}$	4	110 ~ 140	149 ~ 190
2½	$\frac{5}{8}$	4	110 ~ 140	149 ~ 190
3	$\frac{5}{8}$	4	110 ~ 140	149 ~ 190
4	$\frac{5}{8}$	8	110 ~ 140	149 ~ 190
5	$\frac{3}{4}$	8	220 ~ 250	298 ~ 339
6	$\frac{3}{4}$	8	220 ~ 250	298 ~ 339
8	$\frac{3}{4}$	8	220 ~ 250	298 ~ 339
10	$\frac{7}{8}$	12	320 ~ 400	434 ~ 542
12	$\frac{7}{8}$	12	320 ~ 400	434 ~ 542
14	1	12	360 ~ 520	488 ~ 705
16	1	16	360 ~ 520	488 ~ 705
18	$1\frac{1}{8}$	16	450 ~ 725	610 ~ 982
20	$1\frac{1}{8}$	20	450 ~ 725	610 ~ 982
24	$1\frac{1}{4}$	20	620 ~ 1000	841 ~ 1356

NOTE: Use of a Model 49 sandwich plate may be necessary to insure a proper seal with rubber faced flanges or other non-metallic flange gaskets.

APPENDIX

PRESSURE PERFORMANCE DATA

PRODUCT DATA

HELPFUL INFORMATION

Metric/Imperial Conversion Chart

Decimal Equivalents of Fractions (inches)

Minutes Converted to Decimals of a Degree

Water Pressure to Feet-of-Head

Feet-of-Head of Water to Pressure

Pipe Sizes & Wall Thickness

BOLT & SOCKET SIZES

HANGERS FOR STRAIGHT RUNS

PRESSURE PERFORMANCE DATA

Ductile Iron Couplings on Carbon Steel and/or Stainless Steel Pipe

The following tables show maximum working pressures (CWP) of Shurjoint ductile iron couplings and flange adapters used on both carbon steel and stainless steel pipes. Shurjoint ductile iron couplings can be used in conjunction with stainless steel pipe in non-corrosive environment as the flow media does not come in direct contact with the coupling housings but rather only the gasket.

Model Z05 on Carbon Steel Pipe

Unit: psi / Bar

Nom. Size in / mm	Cut-Grooved		Roll-Grooved		
	XS	STD	STD	Sch. 10	Sch. 7
1¼	600	600	500	400	250
32	42	42	35	28	17
1½	600	600	500	400	250
40	42	42	35	28	17
2	600	600	500	400	250
50	42	42	35	28	17
2½	600	600	500	400	250
65	42	42	35	28	17
3	600	600	500	400	250
80	42	42	35	28	17
4	600	600	500	400	200
100	42	42	35	28	14
5	450	450	350	300	175
125	31	31	24	20	12
6	450	450	350	300	175
150	31	31	24	20	12
8	450	450	350	300	150
200	31	31	24	20	10

Model Z05 on Stainless Steel Pipe

Unit: psi / Bar

Nom. Size in / mm	Cut-Grooved		Roll-Grooved		
	Sch. 80S	Sch. 40S	Sch. 40S	Sch. 10S	Sch. 5S
1¼	600	600	450	300	250
32	42	42	31	20	17
1½	600	600	450	300	250
40	42	42	31	20	17
2	600	600	450	300	250
50	42	42	31	20	17
2½	600	600	450	300	250
65	42	42	31	20	17
3	600	600	450	300	250
80	42	42	31	20	17
4	600	600	450	300	200
100	42	42	31	20	14
5	450	450	300	200	
125	31	31	20	14	NR
6	450	450	300	125	
150	31	31	20	9	NR
8	450	450	300	100	
200	31	31	20	7	NR

Model K-9 on Carbon Steel Pipe

Unit: psi / Bar

Nom. Size in / mm	Cut-Grooved		Roll-Grooved		
	XS	STD	STD	Sch. 10	Sch. 7
1½	600	600	500	400	300
32	42	42	35	28	20
1½	600	600	500	400	300
40	42	42	35	28	20
2	600	600	500	400	300
50	42	42	35	28	20
2½	600	600	500	400	300
65	42	42	35	28	20
2½	600	600	500	400	300
65	42	42	35	28	20
3	600	600	500	400	300
80	42	42	35	28	20
4	600	600	500	400	300
100	42	42	35	28	20
5	450	450	450	350	250
125	31	31	31	24	17
5	450	450	450	350	250
125	31	31	31	24	17
6	450	450	450	350	250
150	31	31	31	24	17
6	450	450	450	350	250
150	31	31	31	24	17
8	450	450	300	250	200
200	31	31	20	17	14
8 (K-9H)	450	450	300	250	200
200	31	31	20	17	14

Model K-9 on Stainless Steel Pipe

Unit: psi / Bar

Nom. Size in / mm	Cut-Grooved		Roll-Grooved		
	Sch. 80S	Sch. 40S	Sch. 40S	Sch. 10S	Sch. 5S
1½	600	600	450	300	250
32	42	42	31	20	17
1½	600	600	450	300	250
40	42	42	31	20	17
2	600	600	450	300	250
50	42	42	31	20	17
2½	600	600	450	300	250
65	42	42	31	20	17
2½	600	600	450	300	250
65	42	42	31	20	17
3	600	600	450	300	250
80	42	42	31	20	17
4	600	600	450	300	200
100	42	42	31	20	14
5	450	450	300	200	
125	31	31	20	14	NR
5	450	450	300	200	
125	31	31	20	14	NR
6	450	450	300	125	
150	31	31	20	9	NR
6	450	450	300	125	
150	31	31	20	9	NR
8	450	450	350	100	
200	31	31	24	7	NR
8 (K-9H)	450	450	350	100	
200	31	31	24	7	NR

Model Z07 on Carbon Steel Pipe

Unit: psi / Bar

Nom. Size in / mm	Cut-Grooved		Roll-Grooved		
	XS	STD	STD	Sch. 10	Sch. 7
1¼	750	750	750	600	400
32	52	52	52	42	28
1½	750	750	750	600	400
40	52	52	52	42	28
2	750	750	750	600	400
50	52	52	52	42	28
2½	750	750	750	600	400
65	52	52	52	42	28
2½	750	750	750	600	400
65	52	52	52	42	28
3	750	750	750	600	400
80	52	52	52	42	28
4	750	750	750	600	400
100	52	52	52	42	28
5	750	750	750	500	350
125	52	52	52	35	24
5	750	750	750	500	350
125	52	52	52	35	24
6	700	700	700	400	300
150	48	48	48	28	20
6	700	700	700	400	300
150	48	48	48	28	20
8	600	600	600	350	250
200	42	42	42	24	17
10	500	500	500	300	200
250	35	35	35	20	14
12	400	400	400	250	150
300	28	28	28	17	10

Model Z07 on Stainless Steel Pipe

Unit: psi / Bar

Nom. Size in / mm	Cut-Grooved		Roll-Grooved		
	Sch. 80S	Sch. 40S	Sch. 40S	Sch. 10S	Sch. 5S
1¼	750	750	750	600	300
32	52	52	52	42	20
1½	750	750	750	600	300
40	52	52	52	42	20
2	750	750	750	600	300
50	52	52	52	42	20
2½	750	750	750	600	300
65	52	52	52	42	20
2½	750	750	750	600	300
65	52	52	52	42	20
3	750	750	750	500	300
80	52	52	52	35	20
4	750	750	750	500	250
100	52	52	52	35	17
5	750	750	650	500	NR
125	52	52	45	35	NR
5	750	750	650	500	NR
125	52	52	45	35	NR
6	700	700	600	300	NR
150	48	48	42	20	NR
6	700	700	600	300	NR
150(168.3 mm)	48	48	42	20	NR
8	600	600	450	300	NR
200	42	42	31	20	NR
10	500	500	450	150	NR
250	35	35	31	10	NR
12	400	400	400	125	NR
300	28	28	28	9	NR

Model 7771 on Carbon Steel Pipe

Unit: psi / Bar

Nom. Size in / mm	Cut-Grooved		Roll-Grooved		
	XS	STD	STD	Sch. 10	Sch. 7
1½	750	750	750	600	400
40	52	52	52	42	28
2	750	750	750	600	400
50	52	52	52	42	28
2½	750	750	750	600	400
65	52	52	52	42	28
2½	750	750	750	600	400
65	52	52	52	42	28
3	750	750	750	600	400
80	52	52	52	42	28
4	750	750	750	600	400
100	52	52	52	42	28
5	750	750	750	500	350
125	52	52	52	35	24
5	750	750	750	500	350
125	52	52	52	35	24
6	700	700	700	400	300
150	48	48	48	28	20
6	700	700	700	400	300
150	48	48	48	28	20
8	600	600	600	350	250
200	42	42	42	24	17
10	500	500	500	300	200
250	35	35	35	20	14
12	400	400	400	250	150
300	28	28	28	17	10

Model 7771 on Stainless Steel Pipe

Unit: psi / Bar

Nom. Size in / mm	Cut-Grooved		Roll-Grooved		
	Sch. 80S	Sch. 40S	Sch. 40S	Sch. 10S	Sch. 5S
1½	750	750	700	500	300
40	52	52	48	35	20
2	750	750	700	500	300
50	52	52	48	35	20
2½	750	750	700	500	300
65	52	52	48	35	20
2½	750	750	700	500	300
65	52	52	48	35	20
3	750	750	700	500	300
80	52	52	48	35	20
4	750	750	700	400	250
100	52	52	48	28	17
5	750	750	600	300	
125	52	52	42	20	NR
5	750	750	600	300	
125	52	52	42	20	NR
6	700	700	500	200	
150	48	48	35	14	NR
6	700	700	500	200	
150	48	48	35	14	NR
8	600	600	400	150	
200	42	42	28	10	NR
10	500	500	300	100	
250	35	35	20	7	NR
12	400	400	250	100	
300	28	28	17	7	NR

Model XH-1000 on Carbon Steel Pipe

Unit: psi / Bar

Nom. Size in / mm	Cut-Grooved		Roll-Grooved		
	XS	STD	STD	Sch. 10	Sch. 7
2	1000	1000	1000	750	
50	69	69	69	52	NR
2½	1000	1000	1000	600	
65	69	69	69	42	NR
2½	1000	1000	1000	600	
65	69	69	69	42	NR
3	1000	1000	1000	600	
80	69	69	69	42	NR
4	1000	1000	1000	600	
100	69	69	69	42	NR
6	1000	1000	1000	450	
150	69	69	69	31	NR
6	1000	1000	1000	450	
150	69	69	69	31	NR
8	800	800	800	300	
200	55	55	55	20	NR
10	800	800	800	300	
250	55	55	55	20	NR
12	800	800	800	200	
300	55	55	55	14	NR

Model XH-1000 on Stainless Steel Pipe

Unit: psi / Bar

Nom. Size in / mm	Cut-Grooved		Roll-Grooved		
	Sch. 80S	Sch. 40S	Sch. 40S	Sch. 10S	Sch. 5S
2	1000	1000	750	700	
50	69	69	52	48	NR
2½	1000	1000	750	700	
65	69	69	52	48	NR
2½	1000	1000	750	700	
65	69	69	52	48	NR
3	1000	1000	750	500	
80	69	69	52	35	NR
4	1000	1000	750	500	
100	69	69	52	35	NR
6	1000	1000	750	350	
150	69	69	52	24	NR
6	1000	1000	600	350	
150(168.3 mm)	69	69	45	24	NR
8	800	800	750	350	
200	55	55	52	24	NR
10	800	800	600	300	
250	55	55	42	20	NR
12	800	800	600	300	
300	55	55	42	20	NR

Model G28 on Carbon Steel Pipe

Unit: psi / Bar

Nom. Size in / mm	Cut-Grooved		Roll-Grooved		
	XS	STD	STD	Sch. 10	Sch. 7
1½	300	300	300	300	
40	20	20	20	20	NR
2	300	300	300	300	
50	20	20	20	20	NR
2½	300	300	300	300	
65	20	20	20	20	NR
2½	300	300	300	300	
65	20	20	20	20	NR
3	300	300	300	300	
80	20	20	20	20	NR
4	300	300	300	300	
100	20	20	20	20	NR
5	300	300	300	300	
125	20	20	20	20	NR
5	300	300	300	300	
125	20	20	20	20	NR
6	300	300	300	300	
150	20	20	20	20	NR
6	300	300	300	300	
150	20	20	20	20	NR
8	300	300	300	250	
200	20	20	20	17	NR
10	300	300	300	250	
250	20	20	20	17	NR
12	300	300	300	250	
300	20	20	20	17	NR

Model G28 on Stainless Steel Pipe

Unit: psi / Bar

Nom. Size in / mm	Cut-Grooved		Roll-Grooved		
	Sch. 80S	Sch. 40S	Sch. 40S	Sch. 10S	Sch. 5S
1½	300	300	300	300	
40	20	20	20	20	NR
2	300	300	300	300	
50	20	20	20	20	NR
2½	300	300	300	300	
65	20	20	20	20	NR
2½	300	300	300	300	
65	20	20	20	20	NR
3	300	300	300	300	
80	20	20	20	20	NR
4	300	300	300	175	
100	20	20	20	12	NR
5	300	300	250	150	
125	20	20	17	10	NR
5	300	300	250	150	
125	20	20	17	10	NR
6	300	300	250	150	
150	20	20	17	10	NR
6	300	300	250	150	
150	20	20	17	10	NR
8	300	300	200		
200	20	20	14	NR	NR
10	300	300	200		
250	20	20	14	NR	NR
12	300	300	200		
300	20	20	14	NR	NR

Model 7705 on Carbon Steel Pipe

Unit: psi / Bar

Nom. Size in / mm	Cut-Grooved		Roll-Grooved		
	XS	STD	STD	Sch. 10	Sch. 7
1	600	600	500	400	300
25	42	42	35	28	20
1¼	600	600	500	400	300
32	42	42	35	28	20
1½	600	600	500	400	300
40	42	42	35	28	20
2	600	600	500	400	300
50	42	42	35	28	20
2½	600	600	500	400	300
65	42	42	35	28	20
2½	600	600	500	400	300
65	42	42	35	28	20
3	600	600	500	400	300
80	42	42	35	28	20
4	600	600	500	400	300
100	42	42	35	28	20
5	450	450	450	350	250
125	31	31	31	24	17
5	450	450	450	350	250
125	31	31	31	24	17
6	450	450	450	350	250
150	31	31	31	24	17
6	450	450	450	350	250
150	31	31	31	24	17
8	450	450	300	250	200
200	31	31	20	17	14
10	350	350	300	200	175
250	24	24	20	14	12
12	350	350	300	200	175
300	24	24	20	14	12

Model 7705 on Stainless Steel Pipe

Unit: psi / Bar

Nom. Size in / mm	Cut-Grooved		Roll-Grooved		
	Sch. 80S	Sch. 40S	Sch. 40S	Sch. 10S	Sch. 5S
1	600	600	750	500	250
25	42	42	52	35	17
1¼	600	600	750	500	250
32	42	42	52	35	17
1½	600	600	650	500	250
40	42	42	45	35	17
2	600	600	500	500	250
50	42	42	35	35	17
2½	600	600	500	500	250
65	42	42	35	35	17
2½	600	600	500	500	250
65	42	42	35	35	17
3	600	600	500	400	250
80	42	42	35	28	17
4	600	600	500	400	200
100	42	42	35	28	14
5	450	450	450	350	
125	31	31	31	24	NR
5	450	450	450	350	
125	31	31	31	24	NR
6	450	450	300	300	
150	31	31	20	20	NR
6	450	450	300	300	
150	31	31	20	20	NR
8	450	450	300	300	
200	31	31	20	20	NR
10	350	350	200	200	
250	24	24	14	14	NR
12	350	350	200	200	
300	24	24	14	14	NR

Model 7707 on Carbon Steel Pipe

Unit: psi / Bar

Nom. Size in / mm	Cut-Grooved		Roll-Grooved		
	XS	STD	STD	Sch. 10	Sch. 7
¾	1000	1000	750	600	500
20	69	69	52	42	35
1	1000	1000	750	600	500
25	69	69	52	42	35
1¼	1000	1000	750	600	500
32	69	69	52	42	35
1½	1000	1000	750	600	500
40	69	69	52	42	35
2	1000	1000	750	600	500
50	69	69	52	42	35
2½	1000	1000	750	600	500
65	69	69	52	42	35
2½	1000	1000	750	600	500
65	69	69	52	42	35
3	1000	1000	750	600	500
80	69	69	52	42	35
4	1000	1000	750	600	400
100	69	69	52	42	28
5	1000	1000	750	500	350
125	69	69	52	35	24
5	1000	1000	750	500	350
125	69	69	52	35	24
6	1000	1000	700	450	300
150	69	69	48	31	20
6	1000	1000	700	450	300
150	69	69	48	31	20
8	800	800	600	350	250
200	55	55	42	24	17
10	800	800	550	300	200
250	55	55	38	20	14
12	800	800	500	300	200
300	55	55	35	20	14

Model 7707 on Stainless Steel Pipe

Unit: psi / Bar

Nom. Size in / mm	Cut-Grooved		Roll-Grooved		
	Sch. 80S	Sch. 40S	Sch. 40S	Sch. 10S	Sch. 5S
¾	750	750	750	500	325
20	52	52	52	35	22
1	750	750	750	500	325
25	52	52	52	35	22
1¼	750	750	750	500	325
32	52	52	52	35	22
1½	750	750	750	500	325
40	52	52	52	35	22
2	750	750	750	500	325
50	52	52	52	35	22
2½	750	750	750	500	325
65	52	52	52	35	22
2½	750	750	750	500	325
65	52	52	52	35	22
3	750	750	750	500	325
80	52	52	52	35	22
4	750	750	750	500	250
100	52	52	52	35	17
5	750	750	650	500	NR
125	52	52	45	35	NR
5	750	750	650	500	NR
125	52	52	45	35	NR
6	750	750	500	200	NR
150	52	52	35	14	NR
6	750	750	500	200	NR
150	52	52	35	14	NR
8	600	600	450	150	NR
200	42	42	31	10	NR
10	600	600	400	125	NR
250	42	42	28	9	NR
12	600	600	400	125	NR
300	42	42	28	9	NR

Model 7706 on Carbon Steel Pipe

Unit: psi / Bar

Nom. Size in / mm	Cut-Grooved		Roll-Grooved		
	XS	STD	STD	Sch. 10	Sch. 7
1½ x 1¼	500	500	500	350	300
40 x 32	35	35	35	24	20
2 x 1½	500	500	500	350	300
50 x 40	35	35	35	24	20
2½ x 2	500	500	500	350	300
65 x 50	35	35	35	24	20
2½ x 2	500	500	500	350	300
65 x 50	35	35	35	24	20
3 x 2	500	500	500	350	300
80 x 50	35	35	35	24	20
3 x 2½	500	500	500	350	300
80 x 65	35	35	35	24	20
4 x 2	500	500	500	350	300
100 x 50	35	35	35	24	20
4 x 2 ½	500	500	500	350	300
100 x 65	35	35	35	24	20
4 x 2 ½	500	500	500	350	300
100 x 65	35	35	35	24	20
4 x 3	500	500	500	300	250
100 x 80	35	35	35	20	17
5 x 4	400	400	400	300	250
125 x 100	28	28	28	20	17
5 x 4	400	400	400	300	250
125 x 100	28	28	28	20	17
6 x 3	400	400	400	300	200
150 x 80	28	28	28	20	14
6 x 3	400	400	400	300	200
150 x 80	28	28	28	20	14
6 x 4	400	400	400	300	175
150 x 100	28	28	28	20	12
6 x 4	400	400	400	300	175
150 x 100	28	28	28	20	12
8 x 6	400	400	400	300	175
200 x 150	28	28	28	20	12
8 x 6	400	400	400	300	175
200 x 150	28	28	28	20	12

Model 7706 on Stainless Steel Pipe

Unit: psi / Bar

Nom. Size in / mm	Cut-Grooved		Roll-Grooved		
	Sch. 80S	Sch. 40S	Sch. 40S	Sch. 10S	Sch. 5S
1½ x 1¼	500	500	350	300	250
40 x 32	35	35	24	20	17
2 x 1½	500	500	350	300	250
50 x 40	35	35	24	20	17
2½ x 2	500	500	350	300	250
65 x 50	35	35	24	20	17
2½ x 2	500	500	350	300	250
65 x 50	35	35	24	20	17
3 x 2	500	500	350	300	250
80 x 50	35	35	24	20	17
3 x 2½	500	500	350	300	250
80 x 65	35	35	24	20	17
4 x 2	500	500	350	300	250
100 x 50	35	35	24	20	17
4 x 2 ½	500	500	350	300	200
100 x 65	35	35	24	20	14
4 x 2 ½	500	500	350	300	200
100 x 65	35	35	24	20	14
4 x 3	500	500	300	250	200
100 x 80	35	35	20	17	14
5 x 4	400	400	300	250	
125 x 100	28	28	20	17	NR
5 x 4	400	400	300	250	
125 x 100	28	28	20	17	NR
6 x 3	400	400	300	200	
150 x 80	28	28	20	14	NR
6 x 3	400	400	300	200	
150 x 80	28	28	20	14	NR
6 x 4	400	400	300	175	
150 x 100	28	28	20	12	NR
6 x 4	400	400	300	175	
150 x 100	28	28	20	12	NR
8 x 6	400	400	300	175	
200 x 150	28	28	20	12	NR
8 x 6	400	400	300	175	
200 x 150	28	28	20	12	NR

Model C-7 on Carbon Steel Pipe

Unit: psi / Bar

Nom. Size in / mm	Cut-Grooved		Roll-Grooved		
	XS	STD	STD	Sch. 10	Sch. 7
1½ x *	500	500	500	350	300
40 x *	35	35	35	24	20
2 x *	500	500	500	350	300
50 x *	35	35	35	24	20
2½ x *	500	500	500	350	300
65 x *	35	35	35	24	20
2½ x *	500	500	500	350	300
65 x *	35	35	35	24	20
3 x *	500	500	500	350	300
80 x *	35	35	35	24	20
4 x *	500	500	500	350	300
100 x *	35	35	35	24	20
6 x *	400	400	400	350	300
150 x *	28	28	28	24	20
6 x *	400	400	400	350	300
150 x *	28	28	28	24	20

* = all branch sizes, threaded and grooved

Model C-7 on Stainless Steel Pipe

Unit: psi / Bar

Nom. Size in / mm	Cut-Grooved		Roll-Grooved		
	Sch. 80S	Sch. 40S	Sch. 40S	Sch. 10S	Sch. 5S
1½ x *	500	500	350	300	250
40 x *	35	35	24	20	17
2 x *	500	500	350	300	250
50 x *	35	35	24	20	17
2½ x *	500	500	350	300	250
65 x *	35	35	24	20	17
2½ x *	500	500	350	300	250
65 x *	35	35	24	20	17
3 x *	500	500	350	300	250
80 x *	35	35	24	20	17
4 x *	500	500	350	300	250
100 x *	35	35	24	20	17
6 x *	400	400	300	300	250
150 x *	28	28	20	20	17
6 x *	400	400	300	300	250
150 x *	28	28	20	20	17

* = all branch sizes, threaded and grooved

Model 7043 on Carbon Steel Pipe

Unit: psi / Bar

Nom. Size in / mm	Cut-Grooved		Roll-Grooved		
	XS	STD	STD	Sch. 10	Sch. 7
2	750	750	750	500	
50	52	52	52	35	NR
2½	750	750	750	500	
65	52	52	52	35	NR
2½	750	750	750	500	
65	52	52	52	35	NR
3	750	750	750	500	
80	52	52	52	35	NR
4	750	750	750	500	
100	52	52	52	35	NR
5	750	750	750	450	
125	52	52	52	31	NR
5	750	750	750	450	
125	52	52	52	31	NR
6	750	750	750	450	
150	52	52	52	31	NR
6	750	750	750	450	
150	52	52	52	31	NR
8	750	750	750	300	
200	52	52	52	20	NR
10	750	750	750	300	
250	52	52	52	20	NR
12	750	750	750	250	
300	52	52	52	17	NR

Hydrostatic shell test: 1125 psi (77 Bar) per ANSI B16.5

Model 7043 on Stainless Steel Pipe

Unit: psi / Bar

Nom. Size in / mm	Cut-Grooved		Roll-Grooved		
	Sch. 80S	Sch. 40S	Sch. 40S	Sch. 10S	Sch. 5S
2	400	400	400		
50	28	28	28	NR	NR
2½	400	400	400		
65	28	28	28	NR	NR
2½	400	400	400		
65	28	28	28	NR	NR
3	400	400	400		
80	28	28	28	NR	NR
4	300	300	300		
100	20	20	20	NR	NR
5	300	300	250		
125	20	20	17	NR	NR
5	300	300	250		
125	20	20	17	NR	NR
6	300	300	200		
150	20	20	14	NR	NR
6	300	300	200		
150	20	20	14	NR	NR
8	250	250	150		
200	17	17	10	NR	NR
10	250	250	150		
250	17	17	10	NR	NR
12	250	250	150		
300	17	17	10	NR	NR

Model 7041 on Carbon Steel Pipe

Unit: psi / Bar

Nom. Size in / mm	Cut-Grooved		Roll-Grooved		
	XS	STD	STD	Sch. 10	Sch. 7
2	300	300	300	250	
50	20	20	20	17	NR
2½	300	300	300	250	
65	20	20	20	17	NR
2½	300	300	300	250	
65	20	20	20	17	NR
3	300	300	300	250	
80	20	20	20	17	NR
4	300	300	300	250	
100	20	20	20	17	NR
5	300	300	300	250	
125	20	20	20	17	NR
5	300	300	300	250	
125	20	20	20	17	NR
6	300	300	300	250	
150	20	20	20	17	NR
6	300	300	300	250	
150	20	20	20	17	NR
8	300	300	300	200	
200	20	20	20	14	NR
10	300	300	300	200	
250	20	20	20	14	NR
12	300	300	300	200	
300	20	20	20	14	NR
14	300	300	300	200	
350	20	20	20	14	NR
16	300	300	300	175	
400	20	20	20	12	NR
18	300	300	300	175	
450	20	20	20	12	NR
20	300	300	300	150	
500	20	20	20	10	NR
24	300	300	300	150	
600	20	20	20	10	NR

Model 7041 on Stainless Steel Pipe

Unit: psi / Bar

Nom. Size in / mm	Cut-Grooved		Roll-Grooved		
	Sch. 80S	Sch. 40S	Sch. 40S	Sch. 10S	Sch. 5S
2	300	300	275	275	250
50	20	20	19	19	17
2½	300	300	275	275	250
65	20	20	19	19	17
2½	300	300	275	275	250
65	20	20	19	19	17
3	300	300	275	275	250
80	20	20	19	19	17
4	300	300	275	275	250
100	20	20	19	19	17
5	300	300	275	200	200
125	20	20	19	14	14
5	300	300	275	200	200
125	20	20	19	14	14
6	300	300	250	200	200
150	20	20	17	14	14
6	300	300	250	200	200
150	20	20	17	14	14
8	300	300	200	75	NR
200	20	20	14	5	NR
10	300	300	200	75	NR
250	20	20	14	5	NR
12	300	300	200	50	NR
300	20	20	14	3	NR
14	250	250	125	NR	NR
350	17	17	9	NR	NR
16	250	250	125	NR	NR
400	17	17	9	NR	NR
18	250	250	125	NR	NR
450	17	17	9	NR	NR
20	250	250	100	NR	NR
500	17	17	7	NR	NR
24	250	250	100	NR	NR
600	17	17	7	NR	NR

Model 7707N on Carbon Steel Pipe

Unit: psi / Bar

Nom. Size in / mm	Cut-Grooved	Roll-Grooved	
	XS (0.500")	STD (0.375")	LW (0.312")
14	300	300	250
350	20	20	17
16	300	300	250
400	20	20	17
18	300	300	250
450	20	20	17
20	300	300	250
500	20	20	17
22	300	300	250
550	20	20	17
24	300	300	250
600	20	20	17

Model 7707L on Carbon Steel Pipe

Unit: psi / Bar

Nom. Size in / mm	Cut-Grooved	Roll-Grooved	
	XS (0.500")	STD (0.375")	LW (0.312")
14	250	175	125
350	17	12	9
16	250	175	125
400	17	12	9
18	250	175	125
450	17	12	9
20	250	175	125
500	17	12	9
22	250	175	125
550	17	12	9
24	250	175	125
600	17	12	9

Model Z07N on Carbon Steel Pipe

Unit: psi / Bar

Nom. Size in / mm	Cut-Grooved	Roll-Grooved	
	XS (0.500")	STD (0.375")	LW (0.312")
14	---	250	200
350	---	17	14
16	---	250	200
400	---	17	14
18	---	250	200
450	---	17	14
20	---	250	200
500	---	17	14
22	---	250	200
550	---	17	14
24	---	250	200
600	---	17	14

PRESSURE PERFORMANCE DATA

Stainless Steel Couplings on Stainless Steel Pipe

The following tables show maximum cold working pressures (CWP) of Shurjoint stainless steel couplings used on stainless steel pipes.

In general it is more difficult to achieve defined groove corners on stainless steel pipe than on carbon steel pipe. Always select the correct roll set for the pipe being grooved and process grooves as defined as possible. Contact your roll-groove tool manufacturer for recommendations.

Proof test pressure: 1.5 times the listed working pressure.

Burst pressure: 3 times the listed working pressure unless otherwise specified.

Model SS-7 Rigid Coupling

Unit: psi / Bar

Nom. Size in / mm	Roll-Grooved		
	Sch. 40S	Sch. 10S	Sch. 5S
1¼	750	500	200
32	52	35	14
1½	750	500	200
40	52	35	14
2	600	500	200
50	42	35	14
2½	600	500	200
65	42	35	14
3	600	500	200
80	42	35	14
4	600	400	200
100	42	28	14
5	600	350	200
125	42	24	14
6	600	300	200
150	42	20	14
8	600	300	200
200	42	20	14

Model SS-5 Rigid Coupling

Unit: psi / Bar

Nom. Size in / mm	Roll-Grooved		
	Sch. 40S	Sch. 10S	Sch. 5S
1¼	600	300	200
32	42	20	14
1½	600	300	200
40	42	20	14
2	600	300	200
50	42	20	14
2½	600	300	200
65	42	20	14
3	600	300	200
80	42	20	14
4	600	300	200
100	42	20	14
5	600	300	200
125	42	20	14
6	600	300	200
150	42	20	14
8	600	300	200
200	42	20	14

Model SS-7X Rigid Coupling

Unit: psi / Bar

Nom. Size in / mm	Roll-Grooved		
	Sch. 40S	Sch. 10S	Sch. 5S
10	600	300	200
250	42	20	14
12	600	300	200
300	42	20	14
14	400	300	200
350	28	20	14
16	400	300	200
400	28	20	14
18	350	300	200
450	24	20	14
20	350	300	200
500	24	20	14
22	300	300	200
550	20	20	14
24	300	300	200
600	20	20	14

*Burst pressure: 2 times the listed working pressure

Model SS-8 Flexible Coupling

Unit: psi / Bar

Nom. Size in / mm	Cut-Grooved	Roll-Grooved		
	Sch. 40S	Sch. 40S	Sch. 10S	Sch. 5S
1	500	500	450	225
25	35	35	31	16
1¼	500	500	450	225
32	35	35	31	16
1½	500	500	450	225
40	35	35	31	16
2	500	500	450	225
50	35	35	31	16
2½	500	500	450	225
65	35	35	31	16
3	500	500	450	225
80	35	35	31	16
4	425	425	400	200
100	29	29	28	14
5	425	425	400	125
125	29	29	28	9
6	425	425	350	125
150	29	29	24	9
8	300	300	200	125
200	20	20	14	9

Model SS-8X Heavy Duty Flexible Coupling

Unit: psi / Bar

Nom. Size in / mm	Cut-Grooved	Roll-Grooved		
	Sch. 40S	Sch. 40S	Sch. 10S	Sch. 5S
1	750	750	500	200
25	52	52	35	14
1¼	750	750	500	200
32	52	52	35	14
1½	750	750	500	200
40	52	52	35	14
2	750	750	500	200
50	52	52	35	14
2½	750	750	500	200
65	52	52	35	14
3	750	750	500	200
80	52	52	35	14
4	750	750	400	200
100	52	52	28	14
5	750	750	400	200
125	52	52	28	14
6	500	500	400	200
150	35	35	28	14
8	425	425	300	200
200	29	29	20	14

Model SS-1200 High Pressure Flexible Coupling

Unit: psi / Bar

Nom. Size in / mm	Roll-Grooved	
	Sch. 80S	Sch. 40S
¾	1200	1200
20	83	83
1	1200	1200
25	83	83
1¼	1200	1200
32	83	83
1½	1200	1200
40	83	83
2	1200	1200
50	83	83
2½	1200	1200
65	83	83
3	1200	1200
80	83	83
4	1200	1200
100	83	83

Model SS-28 Hinged Lever Coupling

Unit: psi / Bar

Nom. Size in / mm	Roll-Grooved		
	Sch. 40S	Sch. 10S	Sch. 5S
1¼	300	300	200
32	20	20	14
1½	300	300	200
40	20	20	14
2	300	300	200
50	20	20	14
2½	300	300	200
65	20	20	14
3	300	300	200
80	20	20	14
4	300	300	200
100	20	20	14
5	200	200	125
125	14	14	9
5	200	200	125
125	14	14	9
6	200	200	125
150	14	14	9

*Burst pressure: 2 times the listed working pressure

PRODUCT DATA

The following charts are the basic dimensions (overall lengths of couplings, center-to-end, end-to-end and take-out) for field cut-in and installation use. Please refer to the latest Shurjoint data sheet at www.shurjoint.com for other dimensions.

Grooved Couplings

Model Z07 Heavy Duty Rigid Couplings

Z05 Rigid Couplings

7705 Flexible Couplings

7707 Heavy Duty Flexible Couplings

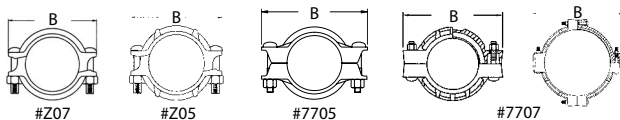

Nominal Size in / mm	Pipe O.D. in / mm	#Z07 B in / mm	#Z05 B in / mm	#7705 B in / mm	#7707 B in / mm
¾	1.050	---	---	---	3.74
20	26.7	---	---	---	95
1	1.315	---	---	3.94	3.90
25	33.4	---	---	100	99
1¼	1.660	4.13	4.00	4.06	4.25
32	42.2	105	102	103	108
1½	1.900	4.53	4.29	4.25	4.88
40	48.3	115	109	108	124
2	2.375	4.72	4.61	5.08	5.24
50	60.3	120	117	129	133
2½	2.875	5.50	5.20	5.59	5.90
65	73.0	140	132	142	150
76.1 mm	3.000	5.75	5.35	5.79	5.90
	76.1	146	136	147	150
3	3.500	6.18	5.83	6.65	6.42
80	88.9	157	148	169	171
101.6 mm	4.000	---	---	7.90	---
	101.6	---	---	200	---
108.0 mm	4.250	---	6.93	7.56	---
	108.0	---	176	192	---
4	4.500	7.83	7.17	7.76	8.38
100	114.3	199	182	197	213
133.0 mm	5.250	---	8.82	9.09	---
	133.0	---	224	231	---
139.7 mm	5.500	9.25	8.94	9.17	9.50
	139.7	235	227	233	241
5	5.563	9.25	9.02	9.21	9.50
125	141.3	235	229	234	241
159.0 mm	6.250	---	9.84	9.96	---
	159.0	---	250	253	---
165.1 mm	6.500	10.20	9.69	10.28	11.26
	165.1	259	246	261	286
6	6.625	10.35	9.80	10.55	11.38
150	168.3	263	249	268	289
8	8.625	13.46	12.99	13.78	14.00
200	219.1	342	330	350	356
8	8.625	---	---	13.50	---
200 (7705H/K9H)	219.1	---	---	343	---
10	10.750	16.98	---	16.73	16.73
250	273.0	431	---	425	425

Model G-28 Hinged Lever Couplings
 K-9 Lightweight Rigid Couplings
 7771 Standard Rigid Couplings
 XH-70EP Extra Heavy Rigid Couplings With EP Gaskets
 XH-1000 Extra Heavy Rigid Couplings
 R20 Rigid Couplings

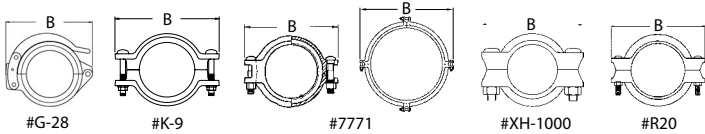

#G-28 B in / mm	#K-9 B in / mm	#7771 B in / mm	#XH-70EP B in / mm	#XH-1000 B in / mm	#R20 B in / mm	Nominal Size in / mm
---	---	---	---	---	---	¾
---	---	---	---	---	---	20
---	---	---	---	---	---	1
---	---	---	---	---	---	25
---	4.33	---	---	---	4.13	1¼
---	110	---	---	---	105	32
4.65	4.45	4.33	---	---	4.25	1½
118	113	100	---	---	108	40
4.76	4.88	4.96	5.90	5.90	4.92	2
121	124	126	150	150	125	50
5.91	5.39	5.82	6.61	6.61	5.43	2½
150	137	148	168	168	138	65
5.91	5.51	5.90	---	---	5.55	76.1 mm
150	140	150	---	---	141	
6.42	5.94	6.69	7.40	6.18	6.18	3
163	151	170	188	188	157	80
---	---	---	---	---	---	101.6 mm
---	---	---	---	---	---	
---	7.00	7.59	---	---	---	108.0 mm
---	219	193	---	---	---	
8.07	7.48	7.79	8.74	8.74	7.52	4
205	190	198	222	222	191	100
---	8.61	9.72	---	---	---	133.0 mm
---	219	247	---	---	---	
9.96	9.21	9.80	---	---	9.21	139.7 mm
253	234	249	---	---	234	
9.96	8.98	9.84	---	---	9.29	5
253	228	250	---	---	236	125
---	9.67	10.70	---	---	---	159.0 mm
---	246	272	---	---	---	
10.94	9.92	11.02	---	---	9.92	165.1 mm
278	252	280	---	---	252	
11.06	10.04	11.02	11.61	11.61	10.08	6
281	255	280	295	295	256	150
14.02	13.98	13.62	14.33	14.33	---	8
356	355	346	364	364	---	200
---	13.08	---	---	---	---	8
---	332	---	---	---	---	200 (7705H/K9H)
17.80	---	16.29	16.70	16.70	---	10
452	---	414	424	424	---	250

Continued on next page

Model Z07 Heavy Duty Rigid Couplings
 Z05 Rigid Couplings
 7705 Flexible Couplings
 7707 Heavy Duty Flexible Couplings

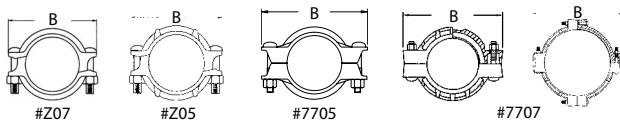

Nominal Size in / mm	Pipe O.D. in / mm	#Z07 B in / mm	#Z05 B in / mm	#7705 B in / mm	#7707 B in / mm
12	12.750	18.88	---	18.39	18.39
300	323.9	480	---	467	467
200 JIS	8.516	13.39	13.39	13.70	14.00
	216.3	340	340	348	356
250 JIS	10.528	15.63	---	16.54	16.54
	267.4	397	---	420	420
300 JIS	12.539	17.80	---	18.81	18.81
	318.5	452	---	478	478
14 (Z07N)	14.000	19.89	---	---	18.0
350	355.6	505	---	---	458
16 (Z07N)	16.000	21.84	---	---	21.9
400	406.4	554	---	---	555
18 (Z07N)	18.000	23.89	---	---	24.1
450	457.2	607	---	---	612
20 (Z07N)	20.000	27.47	---	---	26.4
500	508.0	698	---	---	670
22	22.000	---	---	---	28.7
550	558.8	---	---	---	730
24 (Z07N)	24.000	31.61	---	---	30.4
600	609.6	803	---	---	773

Model G-28 Hinged Lever Couplings
 K-9 Lightweight Rigid Couplings
 7771 Standard Rigid Couplings
 XH-70EP Extra Heavy Rigid Couplings With EP Gaskets
 XH-1000 Extra Heavy Rigid Couplings
 R20 Rigid Couplings

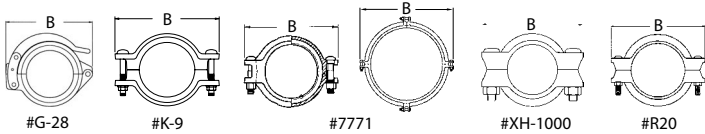

#G-28 B in / mm	#K-9 B in / mm	#7771 B in / mm	#XH-70EP B in / mm	#XH-1000 B in / mm	#R20 B in / mm	Nominal Size in / mm
---	---	18.42	18.90	18.90	---	12
---	---	468	480	480	---	300
---	---	13.62	---	---	13.00	200 JIS
---	---	346	---	---	330	200 JIS
---	---	15.20	---	---	13.31	250 JIS
---	---	386	---	---	338	250 JIS
---	---	17.48	---	---	17.49	300 JIS
---	---	444	---	---	444	300 JIS
---	---	19.76	---	---	---	14 (Z07N)
---	---	502	---	---	---	350
---	---	22.24	---	---	---	16 (Z07N)
---	---	565	---	---	---	400
---	---	24.37	---	---	---	18 (Z07N)
---	---	619	---	---	---	450
---	---	26.88	---	---	---	20 (Z07N)
---	---	683	---	---	---	500
---	---	28.35	---	---	---	22
---	---	720	---	---	---	550
---	---	30.86	---	---	---	24 (Z07N)
---	---	784	---	---	---	600

Model 7706 Reducing Coupling

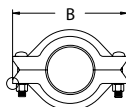

#7706

Nominal Size in / mm	Pipe O.D. in / mm	#7706 B in / mm
1½ x 1¼	1.900 x 1.660	4.25
40 x 32	48.3 x 42.2	108
2 x 1½	2.375 x 1.900	4.80
50 x 40	60.3 x 48.3	122
2½ x 2	2.875 x 2.375	5.67
65 x 50	73.0 x 60.3	144
76.1 mm x 50	3.000 x 2.375	5.43
	76.1 x 60.3	138
3 x 2	3.500 x 2.375	6.61
80 x 50	88.9 x 60.3	168
3 x 2½	3.500 x 2.875	6.61
80 x 65	88.9 x 73.0	168
80 x 76.1 mm	3.500 x 3.000	6.61
	88.9 x 76.1	168
4 x 2	4.500 x 2.375	7.80
100 x 50	114.3 x 60.3	198
4 x 2½	4.500 x 2.875	7.80
100 x 65	114.3 x 73.0	198
100 x 76.1 mm	4.500 x 3.000	7.80
	114.3 x 76.1	198

Nominal Size in / mm	Pipe O.D. in / mm	#7706 B in / mm
4 x 3	4.500 x 3.500	7.80
100 x 80	114.3 x 88.9	198
139.7 mm x 100	5.500 x 4.500	9.84
	139.7 x 114.3	242
5 x 4	5.563 x 4.500	9.84
125 x 100	141.3 x 114.3	242
165.1 mm x 80	6.500 x 3.500	10.59
	165.1 x 88.9	269
6 x 3	6.625 x 3.500	10.83
150 x 80	168.3 x 88.9	275
165.1 mm x 100	6.500 x 4.500	10.59
	165.1 x 114.3	269
6 x 4	6.625 x 4.500	10.83
150 x 100	168.3 x 114.3	275
8 x 6	8.625 x 6.625	13.15
200 x 150	219.1 x 168.3	334
200 x 165.1 mm	8.625 x 6.500	13.15
	219.1 x 165.1	334

Model 7771-T Transition Coupling

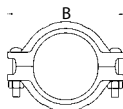

#7771-T

Nominal Size mm	Actual Pipe O.D.		#7771-T B in / mm
	IPS in / mm	JIS in / mm	
200 JIS	8.625	8.515	13.19
	219.1	216.3	335
200 JIS	10.750	10.528	15.20
	273.0	267.4	386
200 JIS	12.750	12.539	17.64
	323.9	318.5	448

Model C-7 Outlet Coupling

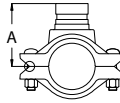

Grooved Outlet

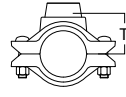

Threaded Outlet

#C-7 Outlet Coupling

Run Pipe in / mm	Nominal Size		#C-7	
	Outlet		T*	A
	FPT in / mm	Gr/MPT in / mm	in / mm	in / mm
1½ 40	½	---	2.06	---
	15	---	52	---
	¾	---	2.06	---
	20	---	52	---
	1	---	1.94	---
2 50	25	---	49	---
	½	---	2.32	---
	15	---	59	---
	¾	---	2.32	---
	20	---	59	---
2½ 65	1	1	2.20	3.50
	25	33.4	56	89.0
	½	---	2.20	---
	15	---	56	---
	¾	---	2.56	---
	20	---	65	---
	1	---	2.44	---
	25	---	62	---
	1¼	1¼	2.36	3.70
	32	42.2	60	94.0
---	1½	---	3.70	
---	48.3	---	94.0	
3 80	¾	---	2.83	---
	20	---	72	---
	1	1	2.75	4.00
	25	33.4	70	102.0
	1¼	1¼	2.75	4.00
	32	42.2	70	102.0
	1½	1½	2.75	4.00
40	48.3	70	102.0	

Run Pipe in / mm	Nominal Size		#C-7	
	Outlet		T*	A
	FPT in / mm	Gr/MPT in / mm	in / mm	in / mm
4 100	¾	---	3.70	---
	20	---	94	---
	1	1	3.58	4.88
	25	33.4	91	124.0
	1½	1½	3.31	4.88
	40	48.3	84	124.0
	2	2	3.50	4.88
6 150	50	60.3	89	124.0
	¾	---	4.76	---
	20	---	121	---
	1	---	4.76	---
	25	---	121	---
	1½	1½	4.76	6.06
	40	48.3	121	154.0
	2	2	4.40	6.06
	50	60.3	111	154.0
	---	2½	---	6.00
---	76.1	---	152.5	

FPT: Female threaded outlet

Gr: Grooved outlet

MPT: Male threaded outlet.

*T: Center of run pipe to end of outlet pipe (dimensions approximate). Female threaded outlet only.

Mechanical Tees

Model 7721, M21 Mechanical Tee Threaded Outlet

7722, M22 Mechanical Tee Grooved Outlet

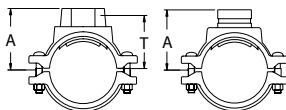

#7721 #M21

#7722, #M22

Nominal Size Run x Branch in / mm	Pipe O.D. in / mm	#7721		#M21		#7722	#M22
		T* in / mm	A in / mm	T* in / mm	A in / mm	A in / mm	A in / mm
2 x ½	2.375 x 0.840	1.97	2.50	1.97	2.50	---	---
50 x 15	60.3 x 21.3	50	64	50	63.5	---	---
2 x ¾	2.375 x 1.050	1.97	2.50	1.97	2.50	---	---
50 x 20	60.3 x 26.7	50	64	50	63.5	---	---
2 x 1	2.375 x 1.315	2.00	2.68	1.85	2.50	2.68	2.87
50 x 25	60.3 x 33.4	51	68	47	63.5	68	73.0
2 x 1¼	2.375 x 1.660	2.08	2.80	2.05	2.87	2.80	3.00
50 x 32	60.3 x 42.2	53	71	52	73.0	71	76.2
2 x 1½	2.375 x 1.900	2.08	2.80	2.08	3.00	2.80	3.00
50 x 40	60.3 x 48.3	53	71	52	76.2	71	76.2
2½ x ½	2.875 x 0.840	2.25	2.80	2.20	2.75	---	---
65 x 15	73.0 x 21.3	57	71	56	69.9	---	---
2½ x ¾	2.875 x 1.050	2.32	2.88	2.20	2.75	---	---
65 x 20	73.0 x 26.7	59	73	56	69.9	---	---
2½ x 1	2.875 x 1.315	2.28	2.95	2.09	2.75	2.95	3.13
65 x 25	73.0 x 33.4	58	75	53	69.9	75	79.4
2½ x 1¼	2.875 x 1.660	2.40	3.11	2.28	3.00	3.11	3.25
65 x 32	73.0 x 42.2	61	79	58	76.2	79	82.6
2½ x 1½	2.875 x 1.900	2.40	3.11	2.28	3.00	3.11	3.25
65 x 40	73.0 x 48.3	61	79	58	76.2	79	82.6
76.1 mm x 15	3.000 x 0.840	2.25	2.80	2.20	2.75	---	---
	76.1 x 21.3	57	71	56	69.9	---	---
76.1 mm x 20	3.000 x 1.050	2.32	2.88	2.20	2.75	---	---
	76.1 x 26.7	59	73	56	69.9	---	---
76.1 mm x 25	3.000 x 1.315	2.28	2.95	2.09	2.75	2.95	3.13
	76.1 x 33.4	58	75	53	69.9	75	79.4
76.1 mm x 32	3.000 x 1.660	2.40	3.11	2.28	3.00	3.11	3.25
	76.1 x 42.2	61	79	58	76.2	79	82.6
76.1 mm x 40	3.000 x 1.900	2.40	3.11	2.28	3.00	3.11	3.25
	76.1 x 48.3	61	79	58	76.2	79	82.6
3 x ½	3.500 x 0.840	2.47	3.19	2.36	3.06	---	---
80 x 15	88.9 x 21.3	63	81	60	77.8	---	---
3 x ¾	3.500 x 1.050	2.44	3.19	2.32	3.06	---	---
80 x 20	88.9 x 26.7	62	81	59	77.8	---	---
3 x 1	3.500 x 1.315	2.50	3.19	2.40	3.06	3.30	3.37
80 x 25	88.9 x 33.4	64	81	61	77.8	84	85.7
3 x 1¼	3.500 x 1.660	2.80	3.50	2.56	3.25	3.50	3.56
80 x 32	88.9 x 42.2	71	89	65	82.6	89	90.5
3 x 1½	3.500 x 1.900	2.80	3.50	2.80	3.50	3.50	3.56
80 x 40	88.9 x 48.3	71	89	71	88.9	89	90.5
3 x 2	3.500 x 2.375	2.83	3.58	2.76	3.50	3.58	3.56
80 x 50	88.9 x 60.3	72	91	70	88.9	91	90.5
4 x ½	4.500 x 0.840	3.00	3.70	2.83	3.69	---	---
100 x 15	114.3 x 21.3	76	94	72	93.7	---	---
4 x ¾	4.500 x 1.050	2.95	3.70	2.79	3.69	---	---
100 x 20	114.3 x 26.7	75	94	71	93.7	---	---
4 x 1	4.500 x 1.315	3.03	3.70	2.87	3.69	3.89	3.69
100 x 25	114.3 x 33.4	77	94	73	93.7	94	93.7

Nominal Size Run x Branch in / mm	Pipe O.D. in / mm	#7721		#M21		#7722	#M22
		T* in / mm	A in / mm	T* in / mm	A in / mm	A in / mm	A in / mm
4 x 1¼	4.500 x 1.660	3.19	3.89	3.07	3.63	3.89	3.63
100 x 32	114.3 x 42.2	81	99	78	92.1	99	92.1
4 x 1½	4.500 x 1.900	3.19	3.89	3.31	3.63	3.89	3.63
100 x 40	114.3 x 48.3	81	99	84	92.1	99	92.1
4 x 2	4.500 x 2.375	3.38	4.13	3.27	4.00	4.13	4.00
100 x 50	114.3 x 60.3	86	105	83	101.6	105	101.6
4 x 2½	4.500 x 2.875	3.23	4.37	2.87	4.00	4.37	4.00
100 x 65	114.3 x 73.0	82	111	73	101.6	111	101.6
100 x 76.1 mm	4.500 x 3.000	3.23	4.37	2.87	4.00	4.37	4.00
	114.3 x 76.1	82	111	73	101.6	111	101.6
4 x 3	4.500 x 3.500	3.23	4.40	3.31	4.13	4.40	4.13
100 x 80	114.3 x 88.9	82	112	84	104.8	112	104.8
139.7 mm x 50	5.500 x 2.375	4.13	4.88	3.27	4.75	4.88	4.75
	139.7 x 60.3	105	124	83	120.7	124	120.7
139.7 mm x 76.1 mm	5.500 x 3.000	3.89	5.00	3.67	4.75	5.00	4.75
	139.7 x 76.1	99	127	93	120.7	127	120.7
139.7 mm x 80	5.500 x 3.500	---	---	3.82	4.75	---	4.63
	139.7 x 88.9	---	---	97	127.0	---	117.5
5 x 2	5.563 x 2.375	4.13	4.88	3.27	4.75	4.88	4.75
125 x 50	141.3 x 60.3	105	124	83	120.7	124	120.7
5 x 2½	5.563 x 2.875	3.89	5.00	3.67	4.75	5.00	4.75
125 x 65	141.3 x 73.0	99	127	93	120.7	127	120.7
5 x 3	5.563 x 3.500	---	---	3.82	4.75	---	4.63
125 x 80	141.3 x 88.9	---	---	97	127.0	---	117.5
165.1 mm x 32	6.500 x 1.660	4.29	5.00	4.41	5.13	5.00	5.13
	165.1 x 42.2	109	127	112	130.2	127	130.2
165.1 mm x 40	6.500 x 1.900	4.29	5.00	4.41	5.13	5.00	5.13
	165.1 x 48.3	109	127	112	130.2	127	130.2
165.1 mm x 50	6.500 x 2.375	4.45	5.29	4.37	5.13	5.20	5.13
	165.1 x 60.3	113	132	111	130.2	132	130.2
165.1 mm x 65	6.500 x 2.875	4.37	5.50	3.98	5.13	5.50	5.13
	165.1 x 73.0	111	140	101	130.2	140	130.2
165.1 mm x 76.1 mm	6.500 x 3.000	4.37	5.50	3.98	5.13	5.50	5.13
	165.1 x 76.1	111	140	101	130.2	140	130.2
165.1 mm x 80	6.500 x 3.500	4.33	5.50	4.33	5.50	5.50	5.13
	165.1 x 88.9	110	140	110	139.7	140	130.2
165.1 mm x 100	6.500 x 4.500	4.21	5.50	4.45	5.75	5.50	5.40
	165.1 x 114.3	107	140	113	146.1	140	137.1
6 x 1¼	6.625 x 1.660	4.29	5.00	4.41	5.13	5.00	5.13
150 x 32	168.3 x 42.2	109	127	112	130.2	127	130.2
6 x 1½	6.625 x 1.900	4.29	5.00	4.41	5.13	5.00	5.13
150 x 40	168.3 x 48.3	109	127	112	130.2	127	130.2
6 x 2	6.625 x 2.375	4.45	5.29	4.37	5.13	5.20	5.13
150 x 50	168.3 x 60.3	113	132	111	130.2	132	130.2
6 x 2½	6.625 x 2.875	4.37	5.50	3.98	5.13	5.50	5.13
150 x 65	168.3 x 73.0	111	140	101	130.2	140	130.2
150 x 76.1 mm	6.625 x 3.000	4.37	5.50	3.98	5.13	---	---
	168.3 x 76.1	111	140	101	130.2	---	---
6 x 3	6.625 x 3.500	4.33	5.50	4.33	5.50	5.50	5.13
150 x 80	168.3 x 88.9	110	140	110	139.7	140	130.2
6 x 4	6.625 x 4.500	4.21	5.50	4.45	5.75	5.50	5.40
150 x 100	168.3 x 114.3	107	140	113	146.1	140	137.1
8 x 2	8.625 x 2.375	5.31	6.54	---	---	6.54	---
200 x 50	219.1 x 60.3	135	166	---	---	166	---
8 x 2½	8.625 x 2.875	5.39	6.54	---	---	6.54	---
200 x 65	219.1 x 73.0	137	166	---	---	166	---
219.1 x 76.1 mm	8.625 x 3.000	5.39	6.54	---	---	6.54	---
	219.1 x 76.1	137	166	---	---	166	---
8 x 3	8.625 x 3.500	5.35	6.54	---	---	6.54	---
200 x 80	219.1 x 88.9	136	166	---	---	166	---
8 x 4	8.625 x 4.500	5.24	6.54	---	---	6.54	---
200 x 100	219.1 x 114.3	133	166	---	---	166	---

* Take-Out (Center of run to end of pipe to be engaged.)

Grooved Flange Adapters

Model 723 Saddle-Let

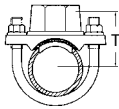

#723

Nominal Size in / mm	Pipe O.D. in / mm	Take-Out, T in / mm
1¼ x ½	1.660 x 0.840	1.38
32 x 15	42.2 x 21.3	35.0
1¼ x ¾	1.660 x 1.050	1.38
32 x 20	42.2 x 26.7	35.0
1¼ x 1	1.660 x 1.315	1.50
32 x 25	42.2 x 33.4	38.0
1½ x ½	1.900 x 0.840	1.38
40 x 15	48.3 x 21.3	35.0
1½ x ¾	1.900 x 1.050	1.38
40 x 20	48.3 x 26.7	35.0
1½ x 1	1.900 x 1.315	1.50
40 x 25	48.3 x 33.4	38.0
2 x ½	2.375 x 0.840	1.65
50 x 15	60.3 x 21.3	42.0
2 x ¾	2.375 x 1.050	1.65
50 x 20	60.3 x 26.7	42.0
2 x 1	2.375 x 1.315	1.77
50 x 25	60.3 x 33.4	45.0
2½ x ½	2.875 x 0.840	2.00
65 x 15	73.0 x 21.3	51.0
2½ x ¾	2.875 x 1.050	2.00
65 x 20	73.0 x 26.7	51.0
2½ x 1	2.875 x 1.315	2.13
65 x 25	73.0 x 33.4	54.0

Model 7180 Flange Adapters

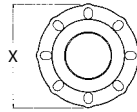

#7180

Nominal Size in / mm	Pipe O.D. in / mm	#7180 X in / mm
2	2.375	6.50
50	60.3	165
2½	2.875	7.28
65	73.0	185
76.1 mm	3.000	7.28
	76.1	185
3	3.500	7.87
80	88.9	200
4	4.500	9.00
100	114.3	229
139.7 mm	5.500	9.84
	139.7	250
5	5.563	9.84
125	141.3	250
165.1 mm	6.500	11.46
	165.1	291
6	6.625	11.46
150	168.3	291
8	8.625	13.50
200	219.1	343
200 JIS	8.516	13.50
	216.3	343

Model 7181 Universal Reducing Flange Adapters

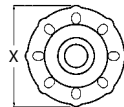

#7181

Nominal Size in / mm	Pipe O.D. in / mm	#7181 X in / mm
3 x 2	3.500 x 2.375	8.19
80 x 50	88.9 x 60.3	208.0
4 x 2½	4.500 x 2.875	8.88
100 x 65	114.3 x 73.0	225.5
100 x 76.1 mm	4.500 x 3.000	8.88
	114.3 x 76.1	225.5
4 x 3	4.500 x 3.500	8.88
100 x 80	114.3 x 88.9	225.5
6 x 4	6.625 x 4.500	11.46
150 x 100	168.3 x 114.3	291.0

Model 7041/7041N Flange Adapters-ANSI Class 125/150

7041/7041N Flange Adapters-PN 10 / PN 16

7043 Flange Adapters

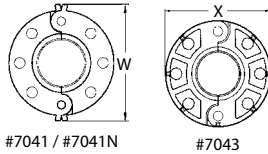

Nominal Size	Pipe O.D.	#7041 #7041N ANSI Class 125/150 W	#7041 #7041N PN 10 / PN 16 W	#7043 X
in / mm	in / mm	in / mm	in / mm	in / mm
2	2.375	6.79	---	6.50
50	60.3	172	185	165
2½	2.875	7.79	---	7.50
65	73.0	198	---	191
76.1 mm	3.000	---	---	---
	76.1	---	205	---
3	3.500	8.29	---	8.25
80	88.9	210	220	210
4	4.500	9.79	---	10.00
100	114.3	249	240	254
5	5.563	10.79	---	11.00
125	141.3	274	---	279
165.1 mm	6.500	---	---	---
	165.1	---	305	---
6	6.625	11.79	---	12.50
150	168.3	299	305	318
8	8.625	14.29	---	15.00
200	219.1	363	360	381
10	10.750	16.79	---	17.50
250	273.0	426	425	445
12	12.750	19.79	---	20.50
300	323.9	502	480	521
14	14.000	21.79	---	---
350	355.6	553	540	---
16	16.000	24.29	---	---
400	406.4	617	600	---
18	18.000	25.79	---	---
450	457.2	655	660	---
20	20.000	28.29	---	---
500	508.0	719	735	---
22	22.000	30.29	---	---
550	559.0	769	---	---
24	24.000	32.79	---	---
600	609.6	833	860	---

Grooved Fittings

Model 7110 90° Elbow
 7111 45° Elbow
 7112 22½° Elbow
 7113 11¼° ELBOW

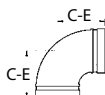

#7110
90° Elbow



#7112G
22½° Elbow (Gooseneck)



#7113
11¼° Elbow



#7111
45° Elbow



#7112
22½° Elbow (Standard)

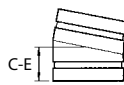

#7113
11¼° Elbow (Welded)

Nominal Size in / mm	Pipe O.D. in / mm	#7110 C-E in / mm	#7111 C-E in / mm	#7112 C-E in / mm	#7112G E-E in / mm	#7113 C-E in / mm
1	1.315	2.25	1.75	---	---	1.38
25	33.4	57	45	---	---	35
1¼	1.660	2.75	1.75	1.75	---	1.38
32	42.2	70	45	45	---	35
1½	1.900	2.75	1.75	1.75	3.75	1.38
40	48.3	70	45	45	95	35
2	2.375	3.25	2.00	1.88	3.75	1.38
50	60.3	83	51	48	95	35
2½	2.875	3.75	2.25	2.01	4.00	1.50
65	73.0	95	57	51	102	38
76.1 mm	3.000	3.75	2.25	2.01	4.00	1.50
	76.1	95	57	51	102	38
3	3.500	4.25	2.50	2.25	4.50	1.50
80	88.9	108	64	57	114	38
101.6 mm	4.000	4.50	---	---	---	---
	101.6	114	---	---	---	---
4	4.500	5.00	3.00	2.88	5.00	1.75
100	114.3	127	76	73	127	45
108.0 mm	4.250	5.00	3.00	---	---	---
	108.0	127	76	---	---	---
133.0 mm	5.250	5.50	3.25	---	---	---
	133.0	140	83	---	---	---
139.7 mm	5.500	5.50	3.25	2.88	5.00	2.00
	139.7	140	83	73	127	51
5	5.563	5.50	3.25	2.88	5.00	2.00
125	141.3	140	83	73	127	51
159.0 mm	6.250	6.50	3.50	---	---	---
	159.0	165	89	---	---	---
165.1 mm	6.500	6.50	3.50	3.12	6.25	2.00
	165.1	165	89	79	159	51

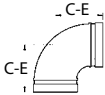

#7110
90° Elbow



#7112G
22½° Elbow (Gooseneck)

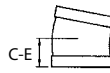

#7113
11¼° Elbow

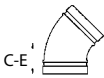

#7111
45° Elbow



#7112
22½° Elbow (Standard)

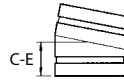

#7113
11¼° Elbow (Welded)

Nominal Size in / mm	Pipe O.D. in / mm	#7110 C-E in / mm	#7111 C-E in / mm	#7112 C-E in / mm	#7112G E-E in / mm	#7113 C-E in / mm
6	6.625	6.50	3.50	3.12	6.25	2.00
150	168.3	165	89	79	159	51
8	8.625	7.75	4.25	3.88	7.75	2.00
200	219.1	197	108	98	197	51
10	10.750	9.00	4.75	4.38	---	2.13
250	273.0	229	121	111	---	54
12	12.750	10.00	5.25	4.88	---	2.25
300	323.9	254	133	124	---	57
8	8.516	7.75	4.25	3.88	7.75	2.00
200JIS	216.3	197	108	98	197	51
10	10.528	9.00	4.75	4.38	---	2.13
250JIS	267.4	229	121	111	---	54
12	12.539	10.00	5.25	4.88	---	2.25
300JIS	318.5	254	133	124	---	57
14	14.000	11.00	6.00	---	---	---
350	355.6	280	152	---	---	---
16	16.000	12.00	7.25	---	---	---
400	406.4	305	184	---	---	---
18	18.000	15.50	8.00	---	---	---
450	457.2	394	203	---	---	---
20	20.000	17.25	9.00	---	---	---
500	508.0	438	229	---	---	---
24	24.000	20.00	11.00	---	---	---
600	609.6	508	280	---	---	---

Shurjoint UL listed fittings are intended for use with Shurjoint listed rubber gasketed fittings.

Model 7120 Tee

7135 Cross

7130 45° Lateral

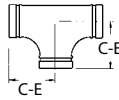

#7120



#7135

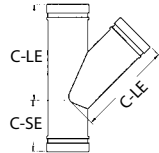

#7130

Nominal Size in / mm	Pipe O.D. in / mm	#7120 C-E in / mm	#7135 C-E in / mm	#7130	
				C-LE in / mm	C-SE in / mm
1	1.315	2.25	---	---	---
25	33.4	57	---	---	---
1¼	1.660	2.75	---	---	---
32	42.2	70	---	---	---
1½	1.900	2.75	---	---	---
40	48.3	70	---	---	---
2	2.375	3.25	3.25	7.00	2.75
50	60.3	83	83	178	70
2½	2.875	3.75	3.75	7.75	3.00
65	73.0	95	95	197	76
76.1 mm	3.000	3.75	3.75	7.75	3.00
	76.1	95	95	197	76
3	3.500	4.25	4.25	8.50	3.25
80	88.9	108	108	216	83
4	4.500	5.00	5.00	10.50	3.75
100	114.3	127	127	267	95
108.0 mm	4.250	5.00	---	---	---
	108.0	127	---	---	---
5	5.563	5.50	5.50	12.50	4.00
125	141.3	140	140	318	102
133.0 mm	5.250	5.50	---	---	---
	133.0	140	---	---	---
139.7 mm	5.500	5.50	5.50	12.50	4.00
	139.7	140	140	318	102
6	6.625	6.50	6.50	14.00	4.50
150	168.3	165	165	356	114
6	6.250	6.50	---	---	---
150	159.0	165	---	---	---
165.1 mm	6.500	6.50	6.50	14.00	4.50
	165.1	165	165	356	114
8	8.625	7.75	7.75	18.00	6.00
200	219.1	197	197	457	152
10	10.750	9.00	---	20.50	6.50
250	273.0	229	---	521	165
12	12.750	10.00	---	23.00	7.00
300	323.9	254	---	584	178
200JIS	8.516	7.75	7.75	18.00	6.00
	216.3	197	197	457	152
250JIS	10.528	9.00	---	20.50	6.50
	267.4	229	---	521	165
300JIS	12.539	10.00	---	23.00	7.00
	318.5	254	---	584	178
14	14.000	11.00	---	---	---
350	355.6	280	---	---	---
16	16.000	12.00	---	---	---
400	406.4	305	---	---	---

Model W110LR LR Wrought 90° Elbow
W111LR LR Wrought 45° Elbow

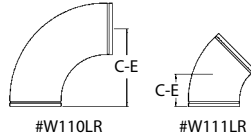

Nominal Size in / mm	Pipe O.D. in / mm	#W110LR C-E in / mm	#W111LR C-E in / mm	Nominal Size in / mm	Pipe O.D. in / mm	#W110LR C-E in / mm	#W111LR C-E in / mm
14	14.000	21.00	8.75	28	28.000	42.00	17.25
350	355.6	533.4	222.3	700	711.0	1066.8	438.2
16	16.000	24.00	10.00	30	30.000	45.00	18.50
400	406.4	609.6	254.0	750	762.0	1143.0	469.9
18	18.000	27.00	11.25	32	32.000	48.00	19.75
450	457.2	685.8	285.5	800	812.8	1219.2	501.7
20	20.000	30.00	12.50	34	34.000	51.00	21.00
500	508.0	762.0	317.5	850	863.6	1295.4	533.4
22	22.000	33.00	13.50	36	36.000	54.00	22.25
550	558.8	838.2	342.9	900	914.4	1371.6	565.2
24	24.000	36.00	15.00	40	40.000	60.00	24.88
600	609.6	914.4	381.0	1000	1016.0	1524.0	632.0
26	26.000	39.00	16.00	42	42.000	63.00	26.00
650	660.4	990.6	406.4	1050	1066.8	1600.2	660.4

Model W120 Wrought Tee

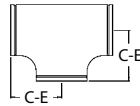

#W120

Nominal Size in / mm	Pipe O.D. in / mm	#W120 Tee C-E in / mm	Nominal Size in / mm	Pipe O.D. in / mm	#W120 Tee C-E in / mm
14	14.000	11.00	28	28.000	20.50
350	355.6	279.4	700	711.0	520.7
16	16.000	12.00	30	30.000	22.00
400	406.4	304.8	750	762.0	558.8
18	18.000	15.50	32	32.000	23.50
450	457.2	393.7*	800	812.8	596.9
20	20.000	17.25	34	34.000	25.00
500	508.0	438.2*	850	863.6	635.0
22	22.000	---	36	36.000	26.50
550	558.8	---	900	914.4	673.1
24	24.000	20.00	40	40.000	29.50
600	609.6	508.0*	1000	1016.0	749.3
26	26.000	19.50	42	42.000	30.00 / 28.00
650	660.4	495.3	1050	1066.8	762.0 / 711.2

*C-E dimensions are manufacturer's standard.

Model 7121 Reducing Tee

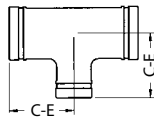

#7121

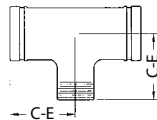

#7121 (Threaded)

Nominal Size in / mm	Pipe O.D. in / mm	#7121	
		Standard C-E in / mm	Threaded Branch C-E in / mm
2 x 2 x 1¼	2.375 x 2.375 x 1.660	3.25	---
50 x 50 x 32	60.3 x 60.3 x 42.2	83	---
2 x 2 x 1½	2.375 x 2.375 x 1.900	3.25	3.25*
50 x 50 x 40	60.3 x 60.3 x 48.3	83	83
2½ x 2½ x 1	2.875 x 2.875 x 1.315	3.75	3.75*
65 x 65 x 25	73.0 x 73.0 x 33.4	95	95
2½ x 2½ x 1¼	2.875 x 2.875 x 1.660	3.75	3.75*
65 x 65 x 32	73.0 x 73.0 x 42.2	95	95
2½ x 2½ x 1½	2.875 x 2.875 x 1.900	3.75	3.75*
65 x 65 x 40	73.0 x 73.0 x 48.3	95	95
2½ x 2½ x 2	2.875 x 2.875 x 2.375	3.75	3.75*
65 x 65 x 50	73.0 x 73.0 x 60.3	95	95
76.1 mm x 76.1 mm x 25	3.000 x 3.000 x 1.315	3.75	3.75*
	76.1 x 76.1 x 33.4	95	95
76.1 mm x 76.1 mm x 32	3.000 x 3.000 x 1.660	3.75	3.75*
	76.1 x 76.1 x 42.2	95	95
76.1 mm x 76.1 mm x 40	3.000 x 3.000 x 1.900	3.75	3.75*
	76.1 x 76.1 x 48.3	95	95
76.1 mm x 76.1 mm x 50	3.000 x 3.000 x 2.375	3.75	3.75*
	76.1 x 76.1 x 60.3	95	95
3 x 3 x ½	3.500 x 3.500 x 0.840	---	---
80 x 80 x 15	88.9 x 88.9 x 21.3	---	---
3 x 3 x ¾	3.500 x 3.500 x 1.050	---	---
80 x 80 x 20	88.9 x 88.9 x 26.7	---	---
3 x 3 x 1	3.500 x 3.500 x 1.315	4.25	4.25
80 x 80 x 25	88.9 x 88.9 x 33.4	108	108
3 x 3 x 1¼	3.500 x 3.500 x 1.660	4.25	4.25*
80 x 80 x 32	88.9 x 88.9 x 42.2	108	108
3 x 3 x 1½	3.500 x 3.500 x 1.900	4.25	4.25*
80 x 80 x 40	88.9 x 88.9 x 48.3	108	108
3 x 3 x 2	3.500 x 3.500 x 2.375	4.25	4.25*
80 x 80 x 50	88.9 x 88.9 x 60.3	108	108
3 x 3 x 2½	3.500 x 3.500 x 2.875	4.25	4.25*
80 x 80 x 65	88.9 x 88.9 x 73.0	108	108
80 x 80 x 76.1 mm	3.500 x 3.500 x 3.000	4.25	4.25
	88.9 x 88.9 x 76.1	108	108
4 x 4 x 1	4.500 x 4.500 x 1.315	5.00	5.00
100 x 100 x 25	114.3 x 114.3 x 33.4	127	127
4 x 4 x 1½	4.500 x 4.500 x 1.900	5.00	5.00*
100 x 100 x 40	114.3 x 114.3 x 48.3	127	127
4 x 4 x 2	4.500 x 4.500 x 2.375	5.00	5.00*
100 x 100 x 50	114.3 x 114.3 x 60.3	127	127
4 x 4 x 2½	4.500 x 4.500 x 2.875	5.00	5.00*
100 x 100 x 65	114.3 x 114.3 x 73.0	127	127
100 x 100 x 76.1 mm	4.500 x 4.500 x 3.000	5.00	5.00*
	114.3 x 114.3 x 76.1	127	127
4 x 4 x 3	4.500 x 4.500 x 3.500	5.00	5.00
100 x 100 x 80	114.3 x 114.3 x 88.9	127	127
139.7 mm x 139.7 mm x 50	5.500 x 5.500 x 2.375	5.50	5.50*
	139.7 x 139.7 x 60.3	140	140

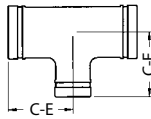

#7121

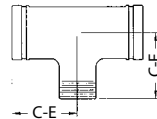

#7121 (Threaded)

Nominal Size in / mm	Pipe O.D. in / mm	#7121	
		Standard C-E in / mm	Threaded Branch C-E in / mm
139.7 mm x 139.7 mm x 65	5.500 x 5.500 x 2.875 139.7 x 139.7 x 73.0	5.50 140	5.50 140
5 x 5 x 2	5.563 x 5.563 x 2.375	5.50	5.50*
125 x 125 x 50	141.3 x 141.3 x 60.3	140	140
5 x 5 x 2½	5.563 x 5.563 x 2.875	5.50	5.50
125 x 125 x 65	141.3 x 141.3 x 73.0	140	140
5 x 5 x 3	5.563 x 5.563 x 3.500	5.50	5.50
125 x 125 x 80	141.3 x 141.3 x 88.9	140	140
5 x 5 x 4	5.563 x 5.563 x 4.500	5.50	5.50
125 x 125 x 100	141.3 x 141.3 x 114.3	140	140
165.1 mm x 165.1 mm x 50	6.500 x 6.500 x 3.000 165.1 x 165.1 x 60.3	6.50 165	6.50* 165
165.1 mm x 165.1 mm x 76.1 mm	6.500 x 6.500 x 3.000 165.1 x 165.1 x 76.1	6.50 165	6.50 165
165.1 mm x 165.1 mm x 80	6.500 x 6.500 x 3.500 165.1 x 165.1 x 88.9	6.50 165	6.50 165
165.1 mm x 165.1 mm x 100	6.500 x 6.500 x 4.500 165.1 x 165.1 x 114.3	6.50 165	6.50 165
6 x 6 x 2	6.625 x 6.625 x 2.375	6.50	6.50*
150 x 150 x 50	168.3 x 168.3 x 60.3	165	165
6 x 6 x 2½	6.625 x 6.625 x 2.875	6.50	6.50*
150 x 150 x 65	168.3 x 168.3 x 73.0	165	165
6 x 6 x 3	6.625 x 6.625 x 3.500	6.50	6.50
150 x 150 x 80	168.3 x 168.3 x 88.9	165	165
6 x 6 x 4	6.625 x 6.625 x 4.500	6.50	6.50
150 x 150 x 100	168.3 x 168.3 x 114.3	165	165
8 x 8 x 2	8.625 x 8.625 x 2.375	7.75	7.75
200 x 200 x 50	219.1 x 219.1 x 60.3	197	197
8 x 8 x 3	8.625 x 8.625 x 3.500	7.75	7.75
200 x 200 x 80	219.1 x 219.1 x 88.9	197	197
8 x 8 x 4	8.625 x 8.625 x 4.500	7.75	7.75
200 x 200 x 100	219.1 x 219.1 x 114.3	197	197
8 x 8 x 6	8.625 x 8.625 x 6.625	7.75	---
200 x 200 x 150	219.1 x 219.1 x 168.3	197	---
10 x 10 x 4	10.750 x 10.750 x 4.500	9.00	9.00
250 x 250 x 100	273.0 x 273.0 x 114.3	229	229
10 x 10 x 6	10.750 x 10.750 x 6.625	9.00	---
250 x 250 x 150	273.0 x 273.0 x 168.3	229	---
10 x 10 x 8	10.750 x 10.750 x 8.625	9.00	---
250 x 250 x 200	273.0 x 273.0 x 219.1	229	---
12 x 12 x 3	12.750 x 12.750 x 3.500	10.00	10.00
300 x 300 x 80	323.9 x 323.9 x 88.9	254	254
12 x 12 x 4	12.750 x 12.750 x 4.500	10.00	10.00
300 x 300 x 100	323.9 x 323.9 x 114.3	254	254
12 x 12 x 6	12.750 x 12.750 x 6.625	10.00	---
300 x 300 x 150	323.9 x 323.9 x 168.3	254	---
12 x 12 x 8	12.750 x 12.750 x 8.625	10.00	---
300 x 300 x 200	323.9 x 323.9 x 219.1	254	---
12 x 12 x 10	12.750 x 12.750 x 10.750	10.00	---
300 x 300 x 250	323.9 x 323.9 x 273.0	254	---

*Female threaded branch is available.

Model W121 Wrought Reducing Tee

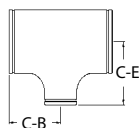

#W121

Nominal Size in / mm	Pipe O.D. in / mm	#W121		Nominal Size in / mm	Pipe O.D. in / mm	#W121	
		C-E in / mm	C-B in / mm			C-E in / mm	C-B in / mm
14 x 6	14.000 x 6.625	11.00	9.37	26 x 18	26.000 x 18.000	19.50	17.50
350 x 150	355.6 x 168.3	279.0	238.0	650 x 450	660.4 x 457.2	495	444.0
14 x 8	14.000 x 8.625	11.00	9.76	26 x 20	26.000 x 20.000	19.50	18.00
350 x 200	355.6 x 219.1	279.0	248.0	650 x 500	660.4 x 508.0	495	457.0
14 x 10	14.000 x 10.750	11.00	10.12	28 x 12	28.000 x 12.750	20.50	17.62
350 x 250	355.6 x 273.0	279.0	257.0	700 x 300	711.0 x 323.9	521	448.0
14 x 12	14.000 x 12.750	11.00	10.63	28 x 14	28.000 x 14.000	20.50	18.00
350 x 300	355.6 x 323.9	279.0	270.0	700 x 350	711.0 x 355.6	521	457.0
16 x 6	16.000 x 6.625	12.00	10.40	28 x 16	28.000 x 16.000	20.50	18.00
400 x 150	406.4 x 168.3	305.0	264.0	700 x 400	711.0 x 406.4	521	457.0
16 x 8	16.000 x 8.625	12.00	10.75	28 x 18	28.000 x 18.000	20.50	18.50
400 x 200	406.4 x 219.1	305.0	273.0	700 x 450	711.0 x 457.2	521	470.0
16 x 10	16.000 x 10.750	12.00	11.14	28 x 20	28.000 x 20.000	20.50	19.00
400 x 250	406.4 x 273.0	305.0	283.0	700 x 500	711.0 x 508.0	521	483.0
16 x 12	16.000 x 12.750	12.00	11.61	28 x 22	28.000 x 22.000	20.50	19.50
400 x 300	406.4 x 323.9	305.0	295.0	700 x 550	711.0 x 559.0	521	495.0
16 x 14	16.000 x 14.000	12.00	12.00	28 x 24	28.000 x 24.000	20.50	20.00
400 x 350	406.4 x 355.6	305.0	305.0	700 x 600	711.0 x 609.6	521	508.0
18 x 6	18.000 x 6.625	13.50	11.38	30 x 18	30.000 x 18.000	22.00	19.50
450 x 150	457.2 x 168.3	343.0	289.0	750 x 450	762.2 x 457.2	559	495.0
18 x 8	18.000 x 8.625	13.50	11.38	30 x 20	30.000 x 20.000	22.00	20.00
450 x 200	457.2 x 219.1	343.0	298.0	750 x 500	762.2 x 508.0	559	508.0
18 x 10	18.000 x 10.750	13.50	12.13	30 x 22	30.000 x 22.000	22.00	20.50
450 x 250	457.2 x 273.0	343.0	308.0	750 x 550	762.2 x 559.0	559	521.0
18 x 12	18.000 x 12.750	13.50	12.64	30 x 24	30.000 x 24.000	22.00	21.00
450 x 300	457.2 x 323.9	343.0	321.0	750 x 610	762.2 x 609.6	559	533.0
18 x 14	18.000 x 14.000	13.50	13.00	30 x 28	30.000 x 28.000	22.00	21.50
450 x 350	457.2 x 355.6	343.0	330.0	750 x 700	762.2 x 711.0	559	546.0
18 x 16	18.000 x 16.000	13.50	13.00	32 x 20	32.000 x 20.000	23.50	21.00
450 x 400	457.2 x 406.4	343.0	330.0	800 x 500	813.0 x 508.0	597	533.0
20 x 6	20.000 x 6.625	15.00	12.36	32 x 22	32.000 x 22.000	23.50	21.50
500 x 150	508.0 x 168.3	381.0	314.0	800 x 550	813.0 x 559.0	597	546.0
20 x 8	20.000 x 8.625	15.00	12.76	32 x 24	32.000 x 24.000	23.50	22.00
500 x 200	508.0 x 219.1	381.0	324.0	800 x 600	813.0 x 609.6	597	559.0

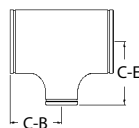

#W121

Nominal Size in / mm	Pipe O.D. in / mm	#W121		Nominal Size in / mm	Pipe O.D. in / mm	#W121	
		C-E in / mm	C-B in / mm			C-E in / mm	C-B in / mm
20 x 10	18.000 x 10.750	18.00	13.11	32 x 28	32.000 x 28.000	23.50	22.50
500 x 250	508.0 x 273.0	381.0	333.0	800 x 700	813.0 x 711.0	597	572.0
20 x 12	20.000 x 12.750	15.00	13.62	32 x 30	32.000 x 30.000	23.50	23.00
500 x 300	508.0 x 323.9	381.0	346.0	800 x 750	813.0 x 762.0	597	584.0
20 x 14	20.000 x 14.000	15.00	14.02	36 x 22	36.000 x 22.000	26.50	23.50
500 x 350	508.0 x 355.6	381.0	356.0	900 x 550	914.0 x 559.0	673	597.0
20 x 16	20.000 x 16.000	15.00	14.02	36 x 24	36.000 x 24.000	26.50	24.00
500 x 400	508.0 x 406.4	381.0	356.0	900 x 600	914.0 x 609.6	673	610.0
20 x 18	20.000 x 18.000	15.00	14.50	36 x 28	36.000 x 28.000	26.50	24.50
500 x 450	508.0 x 457.2	381.0	368.0	900 x 700	914.0 x 711.0	673	622.0
24 x 6	20.000 x 6.625	17.00	14.38	36 x 30	36.000 x 30.000	26.50	25.00
600 x 150	609.6 x 168.3	432.0	365.0	900 x 750	914.0 x 762.0	673	635.0
24 x 8	20.000 x 8.625	17.00	14.76	36 x 32	36.000 x 32.000	26.50	25.50
600 x 200	609.6 x 219.1	432.0	375.0	900 x 800	914.0 x 813.0	673	648.0
24 x 10	24.000 x 10.750	17.00	15.12	40 x 24	40.000 x 24.000	29.50	26.00
600 x 250	609.6 x 273.0	432.0	384.0	1000 x 600	1016.0 x 609.6	749	660.0
24 x 12	24.000 x 12.750	17.00	15.63	40 x 28	40.000 x 28.000	29.50	26.50
600 x 300	609.6 x 323.9	432.0	397.0	1000 x 700	1016.0 x 711.0	749	673.0
24 x 14	24.000 x 14.000	17.00	16.00	40 x 30	40.000 x 30.000	29.50	27.50
600 x 350	609.6 x 355.6	432.0	406.0	1000 x 750	1016.0 x 762.0	749	698.0
24 x 16	24.000 x 16.000	17.00	16.00	42 x 24	42.000 x 24.000	30.00	26.00
600 x 400	609.6 x 406.4	432.0	406.0	1050 x 600	1067.0 x 609.6	762.0	660.0
24 x 18	24.000 x 18.000	17.00	16.50	42 x 28	42.000 x 28.000	30.00	27.50
600 x 450	609.6 x 457.2	432.0	419.0	1050 x 700	1067.0 x 711.0	762.0	698.0
24 x 20	24.000 x 20.000	17.00	17.00	42 x 30	42.000 x 30.000	30.00	28.00
600 x 500	609.6 x 508.0	432.0	432.0	1050 x 750	1067.0 x 762.0	762.0	711.0
26 x 10	26.000 x 10.750	19.50	16.60	42 x 32	42.000 x 32.000	30.00	28.00
650 x 250	660.4 x 273.0	495.0	422.0	1050 x 800	1067.0 x 813.0	762.0	711.0
26 x 12	26.000 x 12.750	19.50	16.60	42 x 36	42.000 x 36.000	30.00	28.00
650 x 300	660.4 x 323.9	495.0	422.0	1050 x 900	1067.0 x 914.0	762.0	711.0
26 x 14	26.000 x 14.000	19.50	17.00	42 x 40	42.000 x 40.000	30.00	28.00
650 x 350	660.4 x 355.6	495.0	432.0	1050 x 1000	1067.0 x 1016.0	762.0	711.0
26 x 16	26.000 x 16.000	19.50	17.00	---	---	---	---
650 x 400	660.4 x 406.4	495.0	432.0	---	---	---	---

Model 7150 Concentric Reducer

7151 Eccentric Reducer

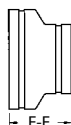

#7150

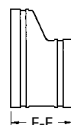

#7151

Nominal Size in / mm	Pipe O.D. in / mm	#7150 E-E in / mm	#7151 E-E in / mm
1¼ x 1	1.660 x 1.315	2.50	---
32 x 25	42.2 x 33.4	64	---
1½ x 1	1.900 x 1.315	2.50	---
40 x 25	48.3 x 33.4	64	---
1½ x 1¼	1.900 x 1.660	2.50	---
40 x 32	48.3 x 42.2	64	---
2 x 1	2.375 x 1.315	2.50	---
50 x 25	60.3 x 33.4	64	---
2 x 1¼	2.375 x 1.660	2.50	---
50 x 32	60.3 x 42.2	64	---
2 x 1½	2.375 x 1.900	2.50	---
50 x 40	60.3 x 48.3	64	---
2½ x 2	2.875 x 2.375	2.50	3.50
65 x 50	73.0 x 60.3	64	89
76.1 mm x 50	3.000 x 2.375	2.50	3.50
	76.1 x 60.3	64	89
3 x 1	3.500 x 1.315	2.50	---
80 x 25	88.9 x 33.4	64	---
3 x 1¼	3.500 x 1.660	2.50	3.50
80 x 32	88.9 x 42.2	64	89
3 x 1½	3.500 x 1.900	2.50	---
80 x 40	88.9 x 48.3	64	---
3 x 2	3.500 x 2.375	2.50	3.50
80 x 50	88.9 x 60.3	64	89
3 x 2½	3.500 x 2.875	2.50	3.50
80 x 65	88.9 x 73.0	64	89
80 x 76.1 mm	3.500 x 3.000	2.50	3.50
	88.9 x 76.1	64	89
4 x 2	4.500 x 2.375	3.00	4.00
100 x 50	114.3 x 60.3	76	102
4 x 2½	4.500 x 2.875	3.00	4.00
100 x 65	114.3 x 73.0	76	102
100 x 76.1 mm	4.500 x 3.000	3.00	4.00
	114.3 x 76.1	76	102
4 x 3	4.500 x 3.500	3.00	4.00
100 x 80	114.3 x 88.9	76	102
5 x 4	5.563 x 4.500	3.50	4.00
125 x 100	141.3 x 114.3	89	102



#7150

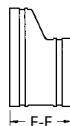

#7151

Nominal Size in / mm	Pipe O.D. in / mm	#7150 E-E in / mm	#7151 E-E in / mm
6 x 2	6.625 x 2.375	4.00	4.00
150 x 50	168.3 x 60.3	102	102
6 x 2½	6.625 x 2.875	4.00	4.00
150 x 65	168.3 x 73.0	102	102
6 x 3	6.625 x 3.500	4.00	4.00
150 x 80	168.3 x 88.9	102	102
6 x 4	6.625 x 4.500	4.00	4.00
150 x 100	168.3 x 114.3	102	102
6 x 5	6.625 x 5.563	4.00	4.00
150 x 125	168.3 x 141.3	102	102
165.1 mm x 50	6.500 x 2.375	4.00	4.00
	165.1 x 60.3	102	102
165.1 mm x 76.1 mm	6.500 x 3.000	4.00	---
	165.3 x 76.1	102	---
165.1 mm x 80	6.500 x 3.500	4.00	4.00
	165.1 x 88.9	102	102
165.1 mm x 100	6.500 x 4.500	4.00	4.00
	165.1 x 114.3	102	102
165.1 mm x 139.7 mm	6.500 x 5.500	4.00	4.00
	165.1 x 139.7	102	102
8 x 3	8.625 x 3.500	5.00	---
200 x 80	219.1 x 88.9	127	---
8 x 4	8.625 x 4.500	5.00	5.00
200 x 100	219.1 x 114.3	127	127
8 x 6	8.625 x 6.625	5.00	5.00
200 x 150	219.1 x 168.3	127	127
10 x 4	10.750 x 4.500	6.00	6.00
250 x 100	273.0 x 114.3	152	152
10 x 6	10.750 x 6.625	6.00	6.00
250 x 150	273.0 x 168.3	152	152
10 x 8	10.750 x 8.625	6.00	7.00
250 x 200	273.0 x 219.1	152	178
12 x 6	12.750 x 6.625	7.00	7.00
300x150	323.9 x 168.3	178	178
12 x 8	12.750 x 8.625	7.00	7.00
300 x 200	323.9 x 219.1	178	178
12 x 10	12.750 x 10.750	7.00	7.00
300 x 250	323.9 x 273.0	178	178

Model W150 Wrought Concentric Reducer
W151 Wrought Eccentric Reducer

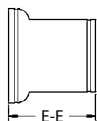

#W150

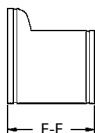

#W151

Nominal Size in / mm	Pipe O.D. in / mm	#W150 E-E in / mm	#W151 E-E in / mm
14 x 6	14.000 x 6.625	13.00	13.00
350 x 150	355.6 x 168.3	330.0	330.0
14 x 8	14.000 x 8.625	13.00	13.00
350 x 200	355.6 x 219.1	330.0	330.0
14 x 10	14.000 x 10.750	13.00	13.00
350 x 250	355.6 x 273.0	330.0	330.0
14 x 12	14.000 x 12.750	13.00	13.00
350 x 300	355.6 x 323.9	330.0	330.0
16 x 8	16.000 x 8.625	14.00	14.00
400 x 200	406.4 x 219.1	356.0	356.0
16 x 10	16.000 x 10.750	14.00	14.00
400 x 250	406.4 x 273.0	356.0	356.0
16 x 12	16.000 x 12.750	14.00	14.00
400 x 300	406.4 x 323.9	356.0	356.0
16 x 14	16.000 x 14.000	14.00	14.00
400 x 350	406.4 x 355.6	356.0	356.0
18 x 10	18.000 x 10.750	15.00	15.00
450 x 250	457.2 x 273.0	381.0	381.0
18 x 12	18.000 x 12.750	15.00	15.00
450 x 300	457.2 x 323.9	381.0	381.0
18 x 14	18.000 x 14.000	15.00	15.00
450 x 350	457.2 x 355.6	381.0	381.0
18 x 16	18.000 x 16.000	15.00	15.00
450 x 400	457.2 x 406.4	381.0	381.0
20 x 12	20.000 x 12.750	20.00	20.00
500 x 300	508.0 x 323.9	508.0	508.0
20 x 14	20.000 x 14.000	20.00	20.00
500 x 350	508.0 x 355.6	508.0	508.0
20 x 16	20.000 x 16.000	20.00	20.00
500 x 400	508.0 x 406.4	508.0	508.0
20 x 18	20.000 x 18.000	20.00	20.00
500 x 450	508.0 x 457.2	508.0	508.0
24 x 16	24.000 x 16.000	20.00	20.00
600 x 400	609.6 x 406.4	508.0	508.0
24 x 18	24.000 x 18.000	20.00	20.00
600 x 450	609.6 x 457.2	508.0	508.0
24 x 20	24.000 x 20.000	20.00	20.00
600 x 500	609.6 x 508.0	508.0	508.0

Model 7110LR 1.5D 90° Elbow
 7111LR 1.5D 45° Elbow
 7137 True-Y

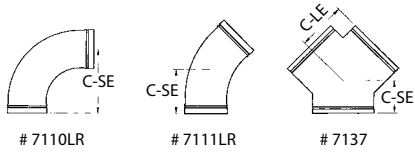

Nominal Size in / mm	Pipe O.D. in / mm	#7110LR C-E in / mm	#7111LR C-E in / mm	#7137	
				C-LE in / mm	C-SE in / mm
2	2.375	4.38	2.75	3.25	2.75
50	60.3	111	70	83	70
2½	2.875	5.00	3.00	3.75	3.00
65	73.0	127	76	95	76
76.1 mm	3.000	5.00	3.00	3.75	3.00
	76.1	127	76	95	76
3	3.500	5.88	3.38	4.25	3.25
80	88.9	149	86	108	83
4	4.500	7.50	4.00	5.00	3.75
100	114.3	191	102	127	95
139.7 mm	5.500	9.50	5.00	5.50	4.00
	139.7	241	127	140	102
5	5.563	9.50	5.00	5.50	4.00
125	141.3	241	127	140	102
165.1 mm	6.500	10.75	5.50	6.50	4.50
	165.1	273	140	165	114
6	6.625	10.75	5.50	6.50	4.50
150	168.3	273	140	165	114
8	8.625	14.25	7.25	7.75	6.00
200	219.1	362	184	197	152
10	10.750	17.25	8.50	9.00	6.50
250	273.0	438	216	229	165
12	12.750	20.50	10.00	10.00	7.00
300	323.9	521	254	254	178

Model 7160 End Cap
7160P End Cap With Plug

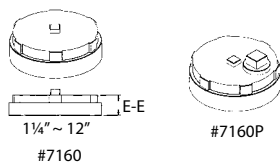

Nominal Size in / mm	Pipe O.D. in / mm	#7160 E-E in / mm	#7160P Plug Size in / mm
1	1.315	0.87	---
25	33.4	22	---
1¼	1.660	1.00	---
32	42.2	25	---
1½	1.900	1.00	---
40	48.3	25	---
2	2.375	1.00	½
50	60.3	25	15
2½	2.875	1.00	½
65	73.0	25	15
76.1 mm	3.000	1.00	½
	76.1	25	15
3	3.500	1.00	½
80	88.9	25	15
4	4.500	1.00	1
100	114.3	25	25
108.0 mm	4.250	1.00	---
	108.0	25	---
5	5.563	1.00	1
125	141.3	25	25
133.0 mm	5.250	1.00	---
	133.0	25	---
139.7 mm	5.500	1.00	1
	139.7	25	25
6	6.625	1.00	1
150	168.3	25	25
159.0 mm	6.250	1.00	---
	159.0	25	---
165.1 mm	6.500	1.00	1
	165.1	25	25
8	8.625	1.18	1½
200	219.1	30	40
10	10.750	1.25	1½
250	273.0	32	40
12	12.750	1.25	1½
300	323.9	32	40
200 JIS	8.516	1.18	---
	216.3	30	---
250 JIS	10.528	1.25	---
	267.4	32	---
300 JIS	12.539	1.25	---
	318.5	32	---

Model 7160H Domed End Cap

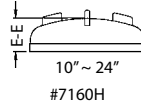

Nominal Size in / mm	Pipe O.D. in / mm	#7160H E-E in / mm
10	10.750	3.00
250	273.0	76.1
12	12.750	3.00
300	323.9	76.1
14	14.000	4.00
350	355.6	102.0
16	16.000	4.00
400	406.4	102.0
18	18.000	5.00
450	457.2	127.0
20	20.000	6.00
500	508.0	152.0
22	22.000	6.00
550	558.8	152.0
24	24.000	6.00
600	609.6	152.0

Model W160 Wrought Cap

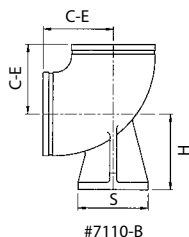

Nominal Size in / mm	Pipe O.D. in / mm	#W160 E-E in / mm	Nominal Size in / mm	Pipe O.D. in / mm	#W160 E-E in / mm
14	14.000	6.50	28	28.000	10.50
350	355.6	165.0	700	711.0	267.0
16	16.000	7.00	30	30.000	10.50
400	406.4	178.0	750	762.0	267.0
18	18.000	8.00	32	32.000	10.50
450	457.2	203.0	800	812.8	267.0
20	20.000	9.00	34	34.000	10.50
500	508.0	229.0	850	863.6	267.0
22	22.000	10.00	36	36.000	10.50
550	558.8	254.0	900	914.4	267.0
24	24.000	10.50	40	40.000	12.00
600	609.6	267.0	1000	1016.0	304.8
26	26.000	10.50	42	42.000	12.00
650	660.4	267.0	1050	1066.8	304.8

Model 7110-B 90° Elbow with Base Support

Nominal Size in / mm	Pipe O.D. in / mm	#7110-B		
		C - E in / mm	H in / mm	S in / mm
3	3.500	4.25	4.88	5.00
80	88.9	108	124	127
4	4.500	5.00	5.50	6.00
100	114.3	127	140	152
6	6.625	6.50	7.00	7.00
150	168.3	165	178	178
8	8.625	7.76	8.38	9.00
200	219.1	197	213	229
10	10.750	9.02	9.75	9.00
250	273.0	229	248	229
12	12.750	10.00	11.25	11.00
300	323.9	254	286	279

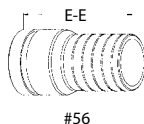
Model 56 Hose Nipple

Nominal Size in / mm	Pipe O.D. in / mm	#56 E-E in / mm	Nominal Size in / mm	Pipe O.D. in / mm	#56 E-E in / mm
1	1.315	3.3	4	4.500	7.25
25	33.4	83	100	114.3	184
1¼	1.660	3.6	5	5.563	9.75
32	42.2	92	125	141.3	248
1½	1.900	4.0	6	6.625	11.0
40	48.3	102	150	168.3	279
2	2.375	4.6	8	8.625	12.5
50	60.3	117	200	219.1	318
2½	2.875	5.5	10	10.750	14.0
65	73.0	140	250	273.0	356
3	3.500	6.0	12	12.750	16.0
80	88.9	152	300	323.9	406

Model 901 SR 90° Elbow
903 Short Radius Tee

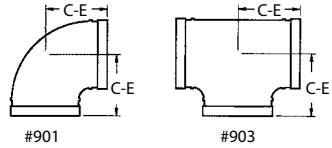

Nominal Size in / mm	Pipe O.D. in / mm	#901 C-E in / mm	#903 C-E in / mm
2	2.375	2.75	2.75
50	60.3	70	70
2½	2.875	3.00	3.00
65	73.0	76	76
2½	3.000	3.00	3.00
65	76.1	76	76
3	3.500	3.38	3.38
80	88.9	86	86
4	4.500	4.00	4.00
100	114.3	102	102
5	5.500	4.88	4.88
125	139.7	124	124
5	5.563	4.88	4.88
125	141.3	124	124
6	6.500	5.50	5.50
150	165.1	140	140
6	6.625	5.50	5.50
150	168.3	140	140
8	8.625	6.94	6.94
200	219.1	176	176

Model 7110DR Drain Elbow

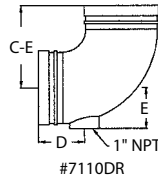

Nominal Size in / mm	Pipe O.D. in / mm	#7110DR		
		C - E in / mm	D in / mm	E in / mm
2	2.375	3.27	2.25	1.57
50	60.3	83	57	40
2½	2.875	3.75	2.75	1.57
65	73.0	95	70	40
76.1 mm	3.000	3.75	2.75	1.57
	76.1	95	70	40
3	3.500	4.25	2.75	1.93
80	88.9	108	70	49
4	4.500	5.00	2.75	2.48
100	114.3	127	70	63
165.1 mm	6.500	6.50	2.75	3.54
	165.1	165	70	90
6	6.625	6.50	2.75	3.54
150	168.3	165	70	90
8	8.625	7.76	3.27	4.49
200	219.1	197	83	114

Model 7150F Reducing Socket (GR x FT)
 7150M Reducing Nipple (GR x MT)
 7160T Transition Fitting

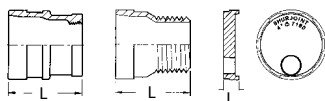

#7150F

#7150M

#7160T

Nominal Size	Pipe O.D.	#7150F (Gr x Ft)	#7150M (Gr x Mt)	#7160T
in / mm	in / mm	L in / mm	L in / mm	L in / mm
1½ x 1	1.900 x 1.315	2.5	2.5	---
40 x 25	48.3 x 33.4	63.5	63.5	---
2 x 1	2.375 x 1.315	2.5	2.5	0.9
50 x 25	60.3 x 33.4	63.5	63.5	23.8
2 x 1¼	2.375 x 1.660	2.5	2.5	0.9
50 x 32	60.3 x 42.2	63.5	63.5	23.8
2 x 1½	2.375 x 1.900	2.5	2.5	---
50 x 40	60.3 x 48.3	63.5	63.5	---
2½ x 1	2.875 x 1.315	2.5	2.5	0.9
65 x 25	73.0 x 33.4	63.5	63.5	23.8
76.1 mm x 25	3.000 x 1.315	2.5	2.5	0.9
	76.1 x 33.4	63.5	63.5	23.8
2½ x 1¼	2.875 x 1.660	2.5	2.5	0.9
65 x 32	73.0 x 42.2	63.5	63.5	23.8
76.1 mm x 32	3.000 x 1.660	2.5	2.5	0.9
	76.1 x 42.2	63.5	63.5	23.8
2½ x 1½	2.875 x 1.900	2.5	2.5	0.9
65 x 40	73.0 x 48.3	63.5	63.5	23.8
76.1 mm x 40	3.000 x 1.900	2.5	2.5	0.9
	76.1 x 48.3	63.5	63.5	23.8
2½ x 2	2.875 x 2.375	2.5	2.5	---
65 x 50	73.0 x 60.3	63.5	63.5	---
76.1 mm x 50	3.000 x 2.375	2.5	2.5	---
	76.1 x 60.3	63.5	63.5	---
3 x 1	3.500 x 1.315	2.5	2.5	1.0
80 x 25	88.9 x 33.4	63.5	63.5	25.4
3 x 1¼	3.500 x 1.660	2.5	2.5	1.0
80 x 32	88.9 x 42.2	63.5	63.5	25.4
3 x 1½	3.500 x 1.900	2.5	2.5	1.0
80 x 40	88.9 x 48.3	63.5	63.5	25.4
3 x 2	3.500 x 2.375	2.5	2.5	1.0
80 x 50	88.9 x 60.3	63.5	63.5	25.4
3 x 2½	3.500 x 2.875	2.5	2.5	---
80 x 65	88.9 x 73.0	63.5	63.5	---
80 x 76.1 mm	3.500 x 3.000	2.5	2.5	---
	88.9 x 76.1	63.5	63.5	---
4 x 1	4.500 x 1.315	---	---	1.0
100 x 25	114.3 x 33.4	---	---	25.4
4 x 1¼	4.500 x 1.660	3	3	1.0
100 x 32	114.3 x 42.2	76.1	76.1	25.4
4 x 1½	4.500 x 1.900	3	3	1.0
100 x 40	114.3 x 48.3	76.1	76.1	25.4
4 x 2	4.500 x 2.375	3	3	1.0
100 x 50	114.3 x 60.3	76.1	76.1	25.4
4 x 2½	4.500 x 2.875	3	3	---
100 x 65	114.3 x 73.0	76.1	76.1	---
4 x 2½	4.500 x 3.000	3	3	---
100 x 65	114.3 x 76.1	76.1	76.1	---

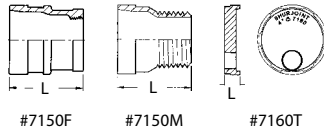

Nominal Size in / mm	Pipe O.D. in / mm	#7150F (Gr x Ft) L in / mm	#7150M (Gr x Mt) L in / mm	#7160T L in / mm
5 x 1½	5.563 x 1.900	3.5	3.5	---
125 x 40	141.3 x 48.3	88.9	88.9	---
139.7 mm x 40	5.500 x 1.900	3.5	3.5	---
	139.7 x 48.3	88.9	88.9	---
6 x 1	6.625 x 1.315	---	---	1.0
150 x 25	168.3 x 33.4	---	---	25.4
6 x 1¼	6.625 x 1.660	---	---	1.0
150 x 32	168.3 x 42.2	---	---	25.4
6 x 1½	6.625 x 1.900	4	4	1.0
150 x 40	168.3 x 48.3	101.6	101.6	25.4
165.1 mm x 40	6.500 x 1.900	4	4	1.0
	165.1 x 48.3	101.6	101.6	25.4
6 x 2	6.625 x 2.375	4	4	1.0
150 x 50	168.3 x 60.3	101.6	101.6	25.4
165.1 mm x 50	6.500 x 2.375	4	4	1.0
	165.1 x 60.3	101.6	101.6	25.4
6 x 2½	6.625 x 2.875	4	4	---
150 x 65	168.3 x 73.0	101.6	101.6	---
165.1 mm x 65	6.500 x 3.000	4	4	---
	165.1 x 76.1	101.6	101.6	---
6 x 4	6.625 x 4.500	4	4	---
150 x 100	168.3 x 114.3	101.6	101.6	---
165.1 mm x 100	6.500 x 4.500	4	4	---
	165.1 x 114.3	101.6	101.6	---

Model 55 Nipple Adapter (GRxMT)

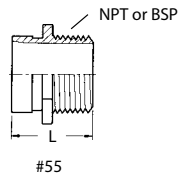

Nominal Size Groove x Thread in / mm	Pipe O.D. in / mm	#55 Nipple L in / mm
1½ G x 1½ M	1.900	2.50
40 G x 40 M	48.3	63.5
2 G x 2 M	2.375	2.50
50 G x 50 M	60.3	63.5

G: Grooved M: Threaded

Model 57 Nipple (Groove x Groove)

58 Nipple (Groove x Bevel)

59 Nipple (Groove x Thread)

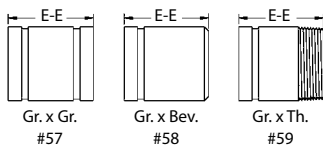

Nominal Size in / mm	Pipe O.D. in / mm	#57 (Gr x Gr) E-E in / mm	#58 (Gr x Bev) E-E in / mm	#59 (Gr x Th) E-E in / mm
¾	1.050	3	3	3
20	26.7	76	76	76
1	1.315	3	3	3
25	33.4	76	76	76
1¼	1.660	4	4	4
32	42.2	102	102	102
1½	1.900	4	4	4
40	48.3	102	102	102
2	2.375	4	4	4
50	60.3	102	102	102
2½	2.875	4	4	4
65	73.0	102	102	102
76.1 mm	3.000	4	4	4
	76.1	102	102	102
3	3.500	4	4	4
80	88.9	102	102	102
4	4.500	6	6	6
100	114.3	152	152	152
5	5.563	6	6	6
125	141.3	152	152	152
139.7 mm	5.500	6	6	6
	139.7	152	152	152
6	6.625	6	6	6
150	168.3	152	152	152
165.1 mm	6.500	6	6	6
	165.1	152	152	152
8	8.625	6	6	---
200	219.1	152	152	---
10	10.750	8	8	---
250	273.0	203	203	---
12	12.750	8	8	---
300	323.9	203	203	---
200 JIS	8.516	6	6	---
	216.3	152	152	---
250 JIS	10.528	8	8	---
	267.4	203	203	---
300 JIS	12.539	8	8	---
	318.5	203	203	---

Model 7127 Standpipe Tee

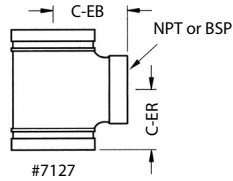

Nominal Size in / mm	Pipe O.D. in / mm	#7127	
		C-ER in / mm	C-EB in / mm
4 x 4 x 2½	4.500 x 4.500 x 2.875	3.25	4.00
100 x 100 x 65	114.3 x 114.3 x 73.0	83	102
6 x 6 x 2½	6.625 x 6.625 x 2.875	3.25	5.00
150 x 150 x 65	168.3 x 168.3 x 73.0	83	127

Model 7125 Bullhead Tee

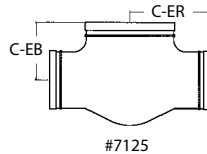

Nominal Size in / mm	Pipe O.D. in / mm	#7125	
		C-ER in / mm	C-EB in / mm
2 x 2 x 2½	2.375 x 2.375 x 2.875	3.74	3.27
50 x 50 x 65	60.3 x 60.3 x 73.0	95	83
2 x 2 x 3	2.375 x 2.375 x 3.500	4.25	3.74
50 x 50 x 80	60.3 x 60.3 x 88.9	108	95
2 x 2 x 4	2.375 x 2.375 x 4.500	5.00	4.02
50 x 50 x 100	60.3 x 60.3 x 114.3	127	102
2½ x 2½ x 3	2.875 x 2.875 x 3.500	4.25	3.75
65 x 65 x 80	73.0 x 73.0 x 88.9	108	95
2½ x 2½ x 4	2.875 x 2.875 x 4.500	5.00	4.00
65 x 65 x 100	73.0 x 73.0 x 114.3	127	102
3 x 3 x 4	3.500 x 3.500 x 4.500	5.00	4.00
80 x 80 x 100	88.9 x 88.9 x 114.3	127	102
4 x 4 x 6	4.500 x 4.500 x 6.625	6.50	5.00
100 x 100 x 150	114.3 x 114.3 x 168.3	165	127
5 x 5 x 8	5.563 x 5.563 x 8.625	7.75	5.50
125 x 125 x 200	141.3 x 141.3 x 219.1	197	140
6 x 6 x 8	6.625 x 6.625 x 8.625	7.75	6.50
150 x 150 x 200	168.3 x 168.3 x 219.1	197	165

Model 899 End-All Fitting

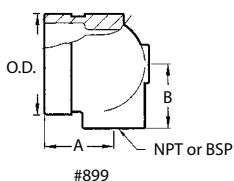

Nominal Size in / mm	Pipe O.D. in / mm	#899	
		A in / mm	B in / mm
1¼ x ½	1.660 42.2	1.750	1.190
32 x 15		44.5	30.1
1¼ x ¾		1.750	1.190
32 x 20		44.5	30.1
1¼ x 1	1.900 48.3	1.900	1.250
32 x 25		48.3	31.8
1½ x ½	1.900 48.3	1.750	1.313
40 x 15		44.5	33.3
1½ x ¾		1.750	1.313
40 x 20		44.5	33.3
1½ x 1	1.900 48.3	1.900	1.375
40 x 25		48.3	34.9
2 x ½	2.375 60.3	1.750	1.562
50 x 15		44.5	39.7
2 x ¾		1.750	1.562
50 x 20		44.5	39.7
2 x 1	1.900 48.3	1.900	1.625
50 x 25		48.3	41.3
2½ x ½	2.875 73.0	1.750	1.750
65 x 15		44.5	44.5
2½ x ¾		1.750	1.750
65 x 20		44.5	44.5
2½ x 1	1.900 48.3	1.900	1.813
65 x 25		48.3	46.0

Model 7114 Hydrant Elbow

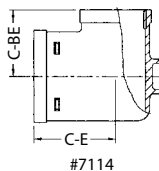

Nominal Size in / mm	Pipe O.D. in / mm	#7114	
		C-E in / mm	C-BE in / mm
4 x 3 x 1	4.500 x 3.500 x 1.315	4.00	3.75
100 x 80 x 25	114.3 x 88.9 x 33.4	102	95
6 x 3 x 1	6.500 x 3.500 x 1.315	5.13	5.13
150 x 80 x 25	165.1 x 88.9 x 33.4	130	130

Model 7122 Hydrant Tee

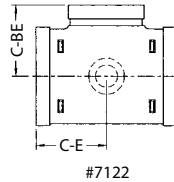

#7122

Nominal Size in / mm	Pipe O.D. in / mm	#7122	
		C-E in / mm	C-BE in / mm
4 x 4 x 3	4.500 x 4.500 x 3.500	4.00	4.00
100 x 100 x 80	114.3 x 114.3 x 88.9	102	102
6 x 6 x 3	6.500 x 6.500 x 3.500	5.13	5.13
150 x 150 x 80	165.1 x 165.1 x 88.9	130	130

Model 7133 Pitcher Tee

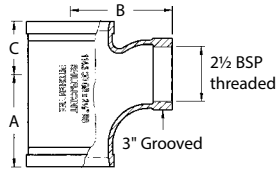

#7133

Nominal Size mm	Pipe O.D. in / mm	#7133		
		A in / mm	B in / mm	C in / mm
80 x 80 x 76.1 mm	3.500 x 3.500 x 3.000	4.75	4.75	2.72
	88.9 x 88.9 x 76.1	121	121	69
100 x 100 x 76.1 mm	4.500 x 4.500 x 3.000	4.75	5.25	2.72
	114.3 x 114.3 x 76.1	121	133	69
150 x 150 x 76.1 mm	6.500 x 6.500 x 3.000	4.75	6.25	2.72
	165.1 x 165.1 x 76.1	121	159	69

Model 10EP 90° Elbow

11EP 45° Elbow

20EP Tee

35EP Cross

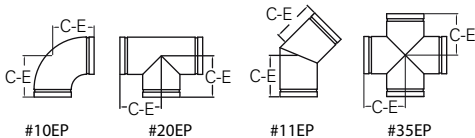

Nominal Size in / mm	Pipe O.D. in / mm	#10EP C-E in / mm	#11EP C-E in / mm	#20EP C-E in / mm	#35EP C-E in / mm
2	2.375	3.25	2.00	3.25	3.25
50	60.3	83	51	83	83
2½	2.875	3.75	2.25	3.75	3.75
65	73.0	95	57	95	95
3	3.500	4.25	2.50	4.25	4.25
80	88.9	108	64	108	108
4	4.500	5.00	3.00	5.00	5.00
100	114.3	127	76	127	127
6	6.625	6.50	3.50	6.50	6.50
150	168.3	165	89	165	165

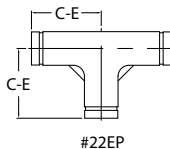
Model 22EP Header Tee

Fitting Size Mated C to E		#22EP C-E
Nominal Size in / mm	Pipe O.D. in / mm	
2 to 3	2.375	4.25
50 to 80	60.3	108
2 to 4	2.875	5.00
50 to 100	73.0	127

Model L90-3D Wrought 3D 90° Elbow
 L60-3D Wrought 3D 60° Elbow
 L45-3D Wrought 3D 45° Elbow
 L30-3D Wrought 3D 30° Elbow
 L22-3D Wrought 3D 22½° Elbow
 L11-3D Wrought 3D 11¼° Elbow

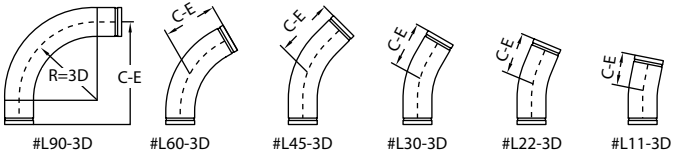

Nominal Size in / mm	Pipe O.D. in / mm	#L90-3D C-E in / mm	#L60-3D C-E in / mm	#L45-3D C-E in / mm	#L30-3D C-E in / mm	#L22-3D C-E in / mm	#L11-3D C-E in / mm
2	2.375	10.00	7.50	6.50	5.75	5.25	4.50
50	60.3	254	191	165	146	133	114
2½	2.875	11.50	8.25	7.25	6.00	5.50	4.75
65	73.0	292	210	184	152	140	121
3	3.500	13.00	9.25	7.75	6.50	5.75	5.00
80	88.9	330	235	197	165	146	127
3½	4.000	14.50	10.00	8.50	6.75	6.00	5.00
90	101.6	368	254	216	171	152	127
4	4.500	16.00	11.00	9.00	7.25	6.50	5.25
100	114.3	406	279	229	184	165	133
5	5.563	20.00	13.75	11.25	9.00	8.00	6.50
125	141.3	508	349	286	229	203	165
6	6.625	24.00	16.50	13.50	10.75	9.50	7.75
150	168.3	610	419	343	273	241	197
8	8.625	32.00	22.00	18.00	14.50	12.75	10.50
200	219.1	813	559	457	368	324	267
10	10.750	40.00	27.25	22.50	18.00	16.00	13.00
250	273.0	1016	692	572	457	406	330
12	12.750	48.00	32.75	27.00	21.75	19.25	15.50
300	323.9	1219	832	686	552	489	394
14	14.000	54.00	38.25	31.50	25.25	22.50	18.25
350	355.6	1372	972	800	641	572	464
16	16.000	60.00	43.75	36.00	29.00	25.25	20.75
400	406.4	1524	1111	914	737	648	527
18	18.000	66.00	49.25	40.25	32.50	28.75	23.35
450	457.2	1676	1251	1029	826	730	593
20	20.000	72.00	54.75	45.00	36.00	32.00	26.00
500	508.0	1829	1391	1143	914	813	660
24	24.000	84.00	65.50	53.75	43.25	38.25	31.00
600	609.6	2134	1664	1365	1099	972	787
28	28.000	95.00	70.00	62.00	47.00	45.00	35.00
700	711.2	2413	1778	1575	1194	1143	889

* For 24" & 28": Made by XS (12.7 mm) carbon steel pipe to ASTM A53.

Model L90-5D Wrought 5D 90° Elbow
 L60-5D Wrought 5D 60° Elbow
 L45-5D Wrought 5D 45° Elbow
 L30-5D Wrought 5D 30° Elbow
 L22-5D Wrought 5D 22½° Elbow
 L11-5D Wrought 5D 11¼° Elbow

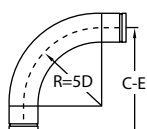

#L90-5D

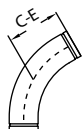

#L60-5D



#L45-5D



#L30-5D



#L22-5D



#L11-5D

Nominal Size in / mm	Pipe O.D. in / mm	#L90-5D C-E in / mm	#L60-5D C-E in / mm	#L45-5D C-E in / mm	#L30-5D C-E in / mm	#L22-5D C-E in / mm	#L11-5D C-E in / mm
2	2.375	14.00	9.75	8.25	6.75	6.00	5.00
50	60.3	356	248	210	171	152	127
2½	2.875	16.50	11.25	9.25	7.50	6.50	5.25
65	73.0	419	286	235	191	165	133
3	3.500	19.00	12.75	10.25	8.00	7.00	5.50
80	88.9	483	324	260	203	178	140
3½	4.000	21.50	12.25	11.25	8.75	7.50	5.75
90	101.6	546	311	286	222	191	146
4	4.500	24.00	15.50	12.50	9.50	8.00	6.00
100	114.3	610	394	318	241	203	152
5	5.563	30.00	19.50	15.50	11.75	10.00	7.50
125	141.3	762	495	394	298	254	191
6	6.625	36.00	23.25	18.50	14.00	12.00	9.00
150	168.3	914	591	470	356	305	229
8	8.625	48.00	31.00	24.50	18.75	16.00	12.00
200	219.1	1219	787	622	476	406	305
10	10.750	60.00	39.00	30.75	23.50	20.00	15.00
250	273.1	1524	991	781	597	508	381
12	12.750	72.00	46.75	37.00	28.00	24.00	18.00
300	323.9	1829	1187	940	711	610	457
14	14.000	82.00	54.50	43.00	32.75	28.00	21.00
350	355.6	2083	1384	1092	832	711	533
16	16.000	92.00	62.25	49.25	37.50	32.00	24.00
400	406.4	2337	1581	1251	953	813	610
18	18.000	102.00	70.00	55.25	42.25	36.00	27.00
450	457.2	2591	1778	1403	1073	914	686
20	20.000	112.00	77.75	61.50	46.75	40.00	30.00
500	508.0	2845	1975	1562	1187	1016	762
24	24.000	132.00	93.25	73.75	56.25	48.00	35.75
600	609.6	3353	2369	1873	1429	1219	908

Model L90-6D Wrought 6D 90° Elbow
 L60-6D Wrought 6D 60° Elbow
 L45-6D Wrought 6D 45° Elbow
 L30-6D Wrought 6D 30° Elbow
 L22-6D Wrought 6D 22½° Elbow
 L11-6D Wrought 6D 11¼° Elbow

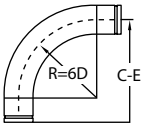

#L90-6D

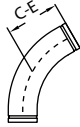

#L60-6D

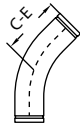

#L45-6D



#L30-6D



#L22-6D



#L11-6D

Nominal Size in / mm	Pipe O.D. in / mm	#L90-6D C-E in / mm	#L60-6D C-E in / mm	#L45-6D C-E in / mm	#L30-6D C-E in / mm	#L22-6D C-E in / mm	#L11-6D C-E in / mm
2	2.375	16.00	11.00	9.00	7.25	6.50	5.25
50	60.3	406	279	229	184	165	133
2½	2.875	19.00	12.75	10.25	8.00	7.00	5.50
65	73.0	483	324	260	203	178	140
3	3.500	22.00	14.50	11.50	8.75	7.50	5.75
80	88.9	559	368	292	222	191	146
3½	4.000	25.00	16.25	12.75	9.75	8.25	6.00
90	101.6	635	413	324	248	210	152
4	4.500	28.00	18.00	14.00	10.50	8.75	6.50
100	114.3	711	457	356	267	222	165
5	5.563	35.00	22.25	17.50	13.00	11.00	8.00
125	141.3	889	565	445	330	279	203
6	6.625	42.00	26.75	21.00	15.75	13.25	9.50
150	168.3	1067	679	533	400	337	241
8	8.625	56.00	35.75	28.00	21.00	17.50	12.75
200	219.1	1422	908	711	533	445	324
10	10.750	70.00	44.75	35.00	26.00	22.00	16.00
250	273.1	1778	1137	889	660	559	406
12	12.750	84.00	53.50	41.75	31.25	26.25	19.00
300	323.9	2134	1359	1060	794	667	483
14	14.000	96.00	62.50	48.75	36.50	30.75	22.25
350	355.6	2438	1588	1238	927	781	565
16	16.000	108.00	71.50	55.75	41.75	35.25	25.50
400	406.4	2743	1816	1416	1060	895	648
18	18.000	120.00	80.50	62.75	47.00	39.50	28.75
450	457.2	3048	2045	1594	1194	1003	730
20	20.000	132.00	89.25	69.75	52.25	44.00	31.75
500	508.0	3353	2267	1772	1327	1118	806
24	24.000	156.00	107.25	83.75	62.50	52.34	38.25
600	609.6	3962	2724	2127	1588	1329	972

Model 850 Sprinkler Hub - 3 Outlets

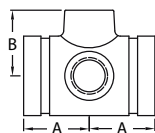

#850

Nominal Size in / mm	#850	
	A in / mm	B in / mm
2 x 2 x 1 (3)	2.38	2.02
50 x 50 x 25 (3)	60	51
2½ x 2½ x 1 (3)	2.38	2.25
65 x 65 x 25 (3)	60	57

(): Number of outlets

Model 851 Reducing Sprinkler Hub - 3 Outlets

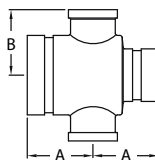

#851

Nominal Size in / mm	#851	
	A in / mm	B in / mm
2 x 1½ x 1 (3)	2.38	2.02
50 x 40 x 25 (3)	60	51
2½ x 1½ x 1 (3)	2.38	2.25
65 x 40 x 25 (3)	60	57
2½ x 2 x 1 (3)	2.38	2.25
65 x 50 x 25 (3)	60	60

(): Number of outlets

Model 853 Sprinkler End Hub - 4 Outlets

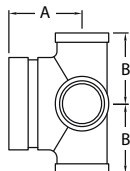

#853

Nominal Size in / mm	#853	
	A in / mm	B in / mm
1½ x 1 (4)	2.38	1.80
40 x 25 (4)	60	46
2 x 1 (4)	2.38	2.02
50 x 25 (4)	60	51
2½ x 1 (4)	2.38	2.25
65 x 25 (4)	60	57

(): Number of outlets

Stainless Steel Series

- Model SS-5 Rigid Coupling
 SS-7 Rigid Coupling
 SS-8 Flexible Coupling
 SS-8X Heavy Duty Flexible Coupling

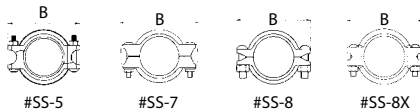

Nominal Size in / mm	Pipe O.D. in / mm	#SS-5 B in / mm	#SS-7 B in / mm	#SS-8 B in / mm	#SS-8X B in / mm
¾	1.050	--	--	--	3.75
20	26.7	--	--	--	95.0
1	1.315	--	--	3.45	3.91
25	33.4	--	--	87.5	99.0
1¼	1.660	4.00	4.13	3.85	4.37
32	42.2	102	105	97.8	111.0
1½	1.900	4.29	4.25	4.14	4.82
40	48.3	109	108	105.1	123.0
2	2.375	4.61	4.92	4.88	5.28
50	60.3	117	125	124.0	134.0
2½	2.875	5.20	5.43	5.51	4.06
65	73.0	132	138	139.9	103.0
76.1 mm	3.000	5.35	5.63	5.71	--
	76.1	136	143	145.0	--
3	3.500	5.83	6.30	6.18	6.74
80	88.9	148	160	157.0	171.0
4	4.500	7.17	8.15	7.87	7.90
100	114.3	182	207	200.0	201.0
139.7 mm	5.500	8.94	9.09	9.09	--
	139.7	227	231	231.0	--
5	5.563	9.02	9.29	8.90	9.80
125	141.3	229	236	226.1	249.0
165.1 mm	6.500	9.69	10.04	9.96	--
	165.1	246	255	253.0	--
6	6.625	9.80	10.08	9.96	10.85
150	168.3	249	256	253.1	276.0
8	8.625	12.99	13.11	13.27	13.43
200	219.1	330	333	337.0	341.0
10	10.750	--	--	--	--
250	273.0	--	--	--	--
12	12.750	--	--	--	--
300	323.9	--	--	--	--
200 JIS	8.516	13.39	13.62	13.62	13.31
	216.3	340	346	346.0	338.0

Model SS-1200 High Pressure Flexible Coupling

SS-41 Flange Adapter

SS-80 Universal Flange Adapter

SS-28 Hinged Lever Coupling

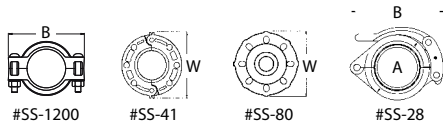

Nominal Size in / mm	#SS-1200 B in / mm	#SS-41 W in / mm	#SS-80 W in / mm	#SS-28 B in / mm
¾	3.70	--	--	--
20	94	--	--	--
1	3.98	--	--	--
25	101	--	--	--
1¼	4.37	--	--	--
111	--	--	--	--
1½	4.61	--	--	4.65
40	117	--	--	118
2	5.39	6.81	6.50	4.76
50	137	173	165	121
2½	--	7.81	7.28	5.91
65	--	198	185	150
76.1 mm	6.04	--	7.28	5.91
	153	--	185	150
3	6.61	8.31	7.78	6.42
80	168	211	200	163
4	8.15	9.81	8.66	8.07
100	207	249	220	205
139.7 mm	--	--	10.00	9.96
	--	--	254	253
5	--	--	10.00	9.96
125	--	--	254	253
165.1 mm	--	--	10.63	10.94
	--	--	270	278
6	--	11.81	11.46	11.06
150	--	300	291	281
8	--	14.31	13.50	--
200	--	363	343	--
10	--	--	16.00	--
250	--	--	406	--
12	--	--	19.00	--
300	30--	--	483	--
200 JIS	--	--	13.50	--
	--	--	343	--

Model SS-7X Rigid Coupling

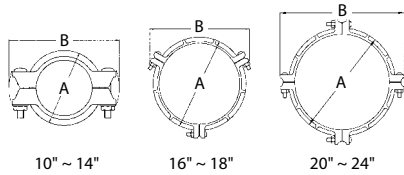

Nominal Size in / mm	Pipe O.D. in / mm	#SS-7X B in / mm
10	10.750	15.98
250	273.0	406
12	12.750	17.78
300	323.9	452
250 JIS	10.528	16.73
	267.4	425
300 JIS	12.539	18.31
	318.5	465
14	14.000	19.69
350	355.6	500
16	16.000	21.10
400	406.4	536
18	18.000	23.11
450	457.2	587
20	20.000	26.34
500	508.0	669
22	22.000	28.35
550	558.8	720
24	24.000	30.35
600	609.6	771

Model SS-723 Mechanical Tee

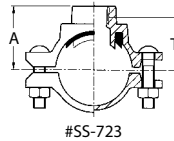

Nominal Size in / mm	#SS-723	
	A in / mm	T in / mm
1¼ x ½	1.60	1.06
32 x 15	41	27
1¼ x ¾	1.70	1.14
32 x 20	44	29
1¼ x 1	2.00	1.34
32 x 25	51	34
1½ x ½	1.70	1.18
40 x 15	44	30
1½ x ¾	1.81	1.22
40 x 20	46	31
1½ x 1	2.09	1.42
40 x 25	53	36
2 x ½	2.00	1.46
50 x 15	51	37
2 x ¾	2.09	1.10
50 x 20	53	28
2 x 1	2.37	1.69
50 x 25	60	43

Model SS-21 Reducing Tee
SS-50 Concentric Reducer

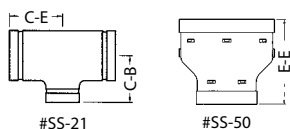

Nominal Size in / mm	Pipe O.D. in / mm	#SS-21		#SS-50
		C-E in / mm	C-B in / mm	E-E in / mm
1½ x 1	1.660 x 1.315	2.76	2.76	2.50
30 x 25	42.2 x 33.4	70	70	64
1½ x 1	1.900 x 1.315	3.25	3.25	2.50
40 x 25	48.3 x 33.4	83	83	64
1½ x 1¼	1.900 x 1.660	3.25	3.25	2.50
40 x 32	48.3 x 42.2	83	83	64
2 x 1	2.375 x 1.315	3.25	3.25	2.50
50 x 25	60.3 x 33.4	83	83	64
2 x 1¼	2.375 x 1.660	3.25	3.25	2.50
50 x 32	60.3 x 42.2	83	83	64
2 x 1½	2.375 x 1.900	3.25	3.25	2.50
50 x 40	60.3 x 48.3	83	83	64
2½ x 1	2.875 x 1.315	3.74	3.74	2.50
65 x 25	73.0 x 33.4	95	95	64
2½ x 1½	2.875 x 1.660	3.74	3.74	2.50
65 x 32	73.0 x 42.2	95	95	64
2½ x 1¼	2.875 x 1.900	3.74	3.74	2.50
65 x 40	73.0 x 48.3	95	95	64
2½ x 2	2.875 x 2.375	3.74	3.74	2.50
65 x 50	73.0 x 60.3	95	95	64
76.1 mm x 25	3.000 x 1.315	3.74	3.74	2.50
	76.1 x 33.4	95	95	64
76.1 mm x 32	3.000 x 1.660	3.74	3.74	2.50
	76.1 x 42.2	95	95	64
76.1 mm x 40	3.000 x 1.900	3.74	3.74	2.50
	76.1 x 48.3	95	95	64
76.1 mm x 50	3.000 x 2.375	3.00	3.00	2.50
	76.1 x 60.3	76	76	64
3 x 1½	3.500 x 1.660	4.25	4.25	2.50
80 x 32	88.9 x 42.2	108	108	64
3 x 1¼	3.500 x 1.900	4.25	4.25	2.50
80 x 40	88.9 x 48.3	108	108	64
3 x 2	3.500 x 2.375	4.25	4.25	2.50
80 x 50	88.9 x 60.3	108	108	64
3 x 2½	3.500 x 2.875	4.25	4.25	2.50
80 x 65	88.9 x 73.0	108	108	64
80 x 76.1 mm	3.500 x 3.000	4.25	4.25	2.50
	88.9 x 76.1	108	108	64
4 x 2	4.500 x 2.375	5.00	5.00	3.00
100 x 50	114.3 x 60.3	127	127	76
4 x 2½	4.500 x 2.875	5.00	5.00	3.00
100 x 65	114.3 x 73.0	127	127	76
100 x 76.1 mm	4.500 x 3.000	5.00	5.00	3.00
	114.3 x 76.1	127	127	76
4 x 3	4.500 x 3.500	5.00	5.00	3.00
100 x 80	114.3 x 88.9	127	127	76

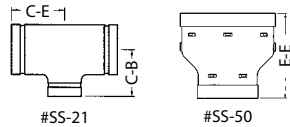

Nominal Size in / mm	Pipe O.D. in / mm	#SS-21		#SS-50
		C-E in / mm	C-B in / mm	E-E in / mm
139.7 mm x 100	5.500 x 4.500	5.50	5.50	3.50
125 x 100	139.7 x 114.3	140	140	89
5 x 4	5.563 x 4.500	5.50	5.50	3.50
125 x 100	141.3 x 114.3	140	140	89
165.1 mm x 80	6.500 x 3.500	6.50	6.50	4.00
	165.1 x 88.9	165	165	102
165.1 mm x 100	6.500 x 4.500	6.50	6.50	4.00
	165.1 x 114.3	165	165	102
165.1 mm x 139.7 mm	6.500 x 5.500	6.50	6.50	4.00
	165.1 x 139.7	165	165	102
6 x 3	6.625 x 3.500	6.50	6.50	4.00
150 x 80	168.3 x 88.9	165	165	102
6 x 4	6.625 x 4.500	6.50	6.50	4.00
150 x 100	168.3 x 114.3	165	165	102
6 x 5	6.625 x 5.563	6.50	6.50	4.00
150 x 125	168.3 x 141.3	165	165	102
8 x 4	8.625 x 4.500	7.76	7.76	5.00
200 x 100	219.1 x 114.3	197	197	127
8 x 5	8.625 x 5.563	7.76	7.76	5.00
200 x 125	219.1 x 141.3	197	197	127
8 x 6	8.625 x 6.625	7.76	7.76	5.00
200 x 150	219.1 x 168.3	197	197	127
10 x 6	10.750 x 6.625	9.02	9.02	6.00
250 x 150	273.0 x 168.3	229	229	152
10 x 8	10.750 x 8.625	9.02	9.02	6.00
250 x 200	273.0 x 219.1	229	229	152
12 x 8	12.750 x 8.625	10.00	10.00	7.00
300 x 200	323.9 x 219.1	254	254	178
12 x 10	12.750 x 10.750	10.00	10.00	7.00
300 x 250	323.9 x 273.0	254	254	178
200 JIS x 100	8.516 x 4.500	7.76	7.76	5.00
	216.3 x 114.3	197	197	127
200 JIS x 125	8.516 x 5.500	7.76	7.76	5.00
	216.3 x 139.7	197	197	127
200 JIS x 165.1 mm	8.516 x 6.500	7.76	7.76	5.00
	216.3 x 165.1	197	197	127
250 JIS x 165.1 mm	10.528 x 6.500	9.02	9.02	6.00
	267.4 x 165.1	229	229	152
250 JIS x 200 JIS	10.528 x 8.516	9.02	9.02	6.00
	267.4 x 216.3	229	229	152
300 JIS x 200 JIS	12.539 x 8.516	10.00	10.00	7.00
	318.5 x 216.3	254	254	178
300 JIS x 250 JIS	12.539 x 10.528	10.00	10.00	7.00
	318.5 x 267.4	254	254	178

Model SS-10 90° Elbow

SS-11 45° Elbow

SS-20 Tee

SS-60 Cap

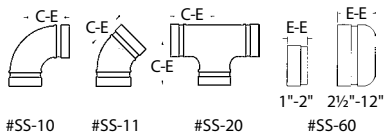

Nominal Size in / mm	Pipe O.D. in / mm	#SS-10 C-E in / mm	#SS-11 C-E in / mm	#SS-20 C-E in / mm	#SS-60 E-E in / mm
1	1.315	2.25	1.75	2.25	0.94
25	33.4	57	45	57	24
1¼	1.660	2.75	1.75	2.75	0.94
32	42.2	70	45	70	24
1½	1.900	2.75	1.75	2.75	0.94
40	48.3	70	45	70	24
2	2.375	3.25	2.00	3.25	0.94
50	60.3	83	51	83	24
2½	2.875	3.75	2.25	3.75	1.75
65	73.0	95	57	95	45
76.1 mm	3.000	3.75	2.25	3.75	1.75
	76.1	95	57	95	45
3	3.500	4.25	2.50	4.25	2.00
80	88.9	108	64	108	51
4	4.500	5.00	3.00	5.00	2.00
100	114.3	127	76	127	51
139.7 mm	5.500	5.50	3.25	5.50	2.38
	139.7	140	83	140	60
5	5.563	5.50	3.25	5.50	2.38
125	141.3	140	83	140	60
165.1 mm	6.500	6.50	3.50	6.50	3.00
	165.1	165	89	165	76
6	6.625	6.50	3.50	6.50	3.00
150	168.3	165	89	165	76
8	8.625	7.75	4.25	7.75	3.50
200	219.1	197	108	197	90
10	10.750	9.00	4.75	9.00	5.00
250	273.0	229	121	229	127
12	12.750	10.00	5.25	10.00	5.71
300	323.9	254	133	254	145
200 JIS	8.516	7.75	4.25	7.75	3.50
	216.3	197	108	197	90
250 JIS	10.528	9.37	4.75	9.00	5.00
	267.4	238	121	229	127
300 JIS	12.539	12.20	5.25	10.00	5.71
	318.5	310	133	254	145

Model WS-10 Wrought 90° Elbow
 WS-10L Long Radius Wrought 90° Elbow
 WS-11 Wrought 45° Elbow
 WS-20 Wrought Tee
 WS-60 Wrought Cap

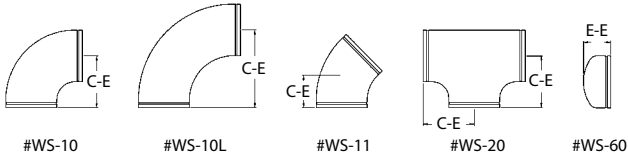

Nominal Size in / mm	Pipe O.D. in / mm	#WS-10 C-E in / mm	#WS-10L C-E in / mm	#WS-11 C-E in / mm	#WS-20 C-E in / mm	#WS-60 E-E in / mm
14	14.000	14.00	21.00	8.75	11.00	6.50
350	355.6	355.6	533.4	222.3	279.4	165.0
16	16.000	16.00	24.00	10.00	12.00	7.00
400	406.4	406.4	609.6	254.0	304.8	178.0
18	18.000	18.00	27.00	11.25	13.50	8.00
450	457.2	457.2	685.8	285.5	342.9	203.0
20	20.000	20.00	30.00	12.50	15.00	9.00
500	508.0	508.0	762.0	317.5	381.0	229.0
24	24.000	24.00	36.00	15.00	17.00	10.50
600	609.6	609.6	914.4	381.0	431.8	267.0

Model WS-21 Wrought Reducing Tee

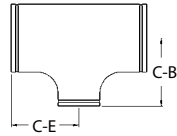

#WS-21

Nominal Size in / mm	Pipe O.D. in / mm	#WS-21	
		C-E in / mm	C-B in / mm
14 x 6	14.000 x 6.625	11.0	9.37
350 x 150	355.6 x 168.3	279.0	238.0
14 x 8	14.000 x 8.625	11.0	9.76
350 x 200	355.6 x 219.1	279.0	248.0
14 x 10	14.000 x 10.750	11.0	10.12
350 x 250	355.6 x 273.0	279.0	257.0
14 x 12	14.000 x 12.750	11.0	10.63
350 x 300	355.6 x 323.9	279.0	270.0
16 x 6	16.000 x 6.625	12.0	10.40
400 x 150	406.4 x 168.3	305.0	264.0
16 x 8	16.000 x 8.625	12.0	10.75
400 x 200	406.4 x 219.1	305.0	273.0
16 x 10	16.000 x 10.750	12.0	11.10
400 x 250	406.4 x 273.0	305.0	282.0
16 x 12	16.000 x 12.750	12.0	11.61
400 x 300	406.4 x 323.9	305.0	295.0
16 x 14	16.000 x 14.000	12.0	12.00
400 x 350	406.4 x 355.6	305.0	305.0

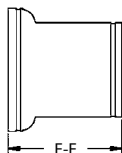
Model WS-50 Wrought Concentric Reducer

#WS-50

Nominal Size in / mm	Pipe O.D. in / mm	#WS-50 E-E in / mm
14 x 6	14.000 x 6.625	11.0
350 x 150	355.6 x 168.3	279.0
14 x 8	14.000 x 8.625	11.0
350 x 200	355.6 x 219.1	279.0
14 x 10	14.000 x 10.750	11.0
350 x 250	355.6 x 273.0	279.0
14 x 12	14.000 x 12.750	11.0
350 x 300	355.6 x 323.9	279.0
16 x 16	16.000 x 6.625	12.0
400 x 150	406.4 x 168.3	305.0
16 x 10	16.000 x 8.625	12.0
400 x 250	406.4 x 219.1	305.0
16 x 10	16.000 x 10.750	12.0
400 x 250	406.4 x 273.0	305.0
16 x 12	16.000 x 12.750	12.0
400 x 300	406.4 x 323.9	305.0
16 x 14	16.000 x 14.000	12.0
400 x 350	406.4 x 355.6	305.0

Plain-end Coupling

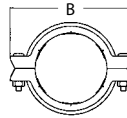
Model 79 "Wildcat" Coupling



#79

Nominal Size in / mm	Pipe O.D. in / mm	#79 B in / mm	Nominal Size in / mm	Pipe O.D. in / mm	#79 B in / mm
1	1.315	4.37	6	6.625	11.50
25	33.4	111	150	168.3	292
1½	1.900	5.08	8	8.625	14.21
40	48.3	129	200	219.1	361
2	2.375	6.75	10	10.750	16.00
50	60.3	171	250	273.0	406
2½	2.875	7.13	12	12.750	18.00
65	73.0	181	300	323.9	457
3	3.500	8.50	14	14.000	20.00
80	88.9	216	350	355.6	508
4	4.500	8.78	16	16.000	22.00
100	114.3	223	400	406.4	559
5	5.563	10.31			
125	141.3	262			

Model H305 HDPE Coupling

H307 HDPE Transition Coupling

H312 HDPE Flange Adapter

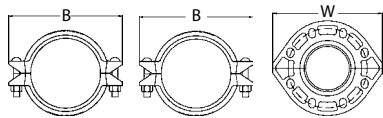

#H305

#H307

#H312

Nominal Size in / mm	Pipe O.D. in / mm	#H305 B in / mm	#H307 B in / mm	#H312 W in / mm
2	2.375	5.24	5.99	---
50	60.3	133	152	---
3	3.500	6.50	7.13	8.86
80	88.9	165	181	225
4	4.500	7.99	8.50	10.25
100	114.3	203	216	260
6	6.625	10.75	11.26	12.25
150	168.3	273	286	311
8	8.625	13.11	13.63	14.75
200	219.1	333	346	375
10	10.750	15.63	17.00	21.00
250	273.0	397	432	533
12	12.750	17.64	19.49	24.00
300	323.9	448	495	610
14	14.000	19.37	---	---
350	355.6	492	---	---
16	16.000	21.38	---	---
400	406.4	543	---	---
18	18.000	23.43	---	---
450	457.2	595	---	---
20	20.000	25.63	---	---
500	508.0	651	---	---

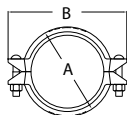
Model H305 ISO HDPE Coupling

#H305

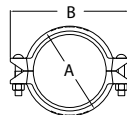
Pipe O.D.		#H305 ISO B mm
Minimum mm	Maximum mm	
50	50.5	115
63	63.6	128
75	75.7	140
90	90.9	169
110	111.0	181
160	161.5	232
180	181.7	253
200	201.8	305
225	226.4	330
250	252.3	351
280	281.7	406
315	317.9	438
355	357.2	489
400	402.4	540
450	452.7	595

**Model H307 ISO HDPE Transition
Coupling**

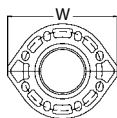
#H307

Pipe O.D.		#H307 ISO B mm
HDPE mm	Steel mm	
63.0	60.3	146
75.0	73.0	146
90.0	88.9	178
110.0	114.3	203
160.0	165.1	254
160.0	168.3	257
200.0	219.1	321
250.0	273.0	432
315.0	323.9	495

**Model H312 ISO HDPE Flange
Adapter**
Adapter

#H312

Pipe O.D.		#H312 ISO B mm
HDPE mm	Steel mm	
63	60.3	196.9
90	88.9	228
110	114.3	251
160	165.1	317
200	219.1	372
250	273.0	532
315	323.9	587

Copper Series

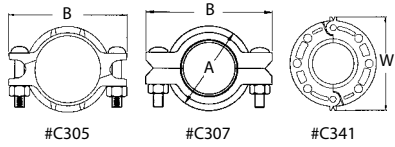
Model C305 Rigid Coupling
C307 Transition Coupling
C341 Flange Adapter



Nominal Size in / mm	Pipe O.D. in / mm	#C305 B in / mm	#C307 B in / mm	#C341 W in / mm
2	2.125	4.63	5.08	6.81
50	54.0	118	129	173
2½	2.625	5.28	5.59	7.81
65	66.7	134	142	198
3	3.125	6.06	6.65	8.31
80	79.4	154	169	211
4	4.125	7.28	7.76	9.81
100	104.8	185	197	249
5	5.125	8.66	---	10.81
125	130.2	220	---	275
6	6.125	9.76	---	11.81
150	155.6	248	---	300

Model C306 Reducing Coupling

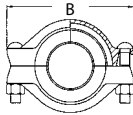

#C306

Nominal Size in / mm	Pipe O.D. in / mm	#C306 B in / mm
2½ x 2	2.625 x 2.125	5.55
65 x 50	66.7 x 54.0	141
3 x 2	3.125 x 2.125	5.98
80 x 50	79.4 x 54.0	152
3 x 2½	3.125 x 2.625	5.98
80 x 65	79.4 x 66.7	152
4 x 2½	4.125 x 2.625	7.20
100 x 65	104.8 x 66.7	183
4 x 3	4.125 x 3.125	7.20
100 x 80	104.8 x 79.4	183
5 x 4	5.125 x 4.125	8.82
125 x 100	130.2 x 104.8	224
6 x 4	6.125 x 4.125	9.88
150 x 100	155.6 x 104.8	251

Model C723 Bronze Mechanical Tee

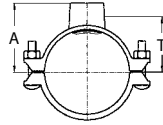

#C723

Nominal CTS x NPT in / mm	# C723	
	A in / mm	T in / mm
2½ x ½	2.60	2.09
65 x 15	66	53
2½ x ¾	2.60	2.05
65 x 20	66	52
2½ x 1	2.60	1.93
65 x 25	66	49
2½ x 1¼	2.87	2.15
65 x 32	73	55
3 x ¾	2.87	2.28
80 x 20	73	58
3 x 1	2.87	2.20
80 x 25	73	56
3 x 1¼	3.31	2.59
80 x 32	84	66
4 x ¾	3.39	2.80
100 x 20	86	71
4 x 1	3.39	3.11
100 x 25	86	79
4 x 1¼	3.81	3.11
100 x 32	97	79

Model C10 90° Elbow

C11 45° Elbow

C20 Tee

C60 Cap

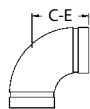

#C10

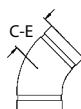

#C11

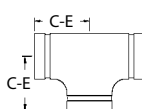

#C20



#C60

Nominal Size in / mm	Pipe O.D. in / mm	#C10 C-E in / mm	#C11 C-E in / mm	#C20 C-E in / mm	#C60 E-E in / mm
2	2.125	2.91	2.19	2.44	0.96
50	54.0	74	56	62	24
2½	2.625	3.31	2.31	3.20	0.96
65	66.7	84	59	81	24
3	3.125	3.81	2.59	3.50	0.96
80	79.4	97	66	89	24
4	4.125	4.75	3.19	4.25	0.96
100	104.8	121	81	108	24
5	5.125	5.94	3.25	5.94	0.96
125	130.2	151	83	151	24
6	6.125	6.94	3.63	6.94	0.96
150	155.6	176	92	176	24

Model C21 Reducing Tee

C50 Concentric Reducer

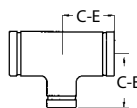

#C21



#C50

Nominal Size in / mm	Pipe O.D. in / mm	#C21 C-E in / mm	#C50 E-E in / mm
2½ x 2	2.625 x 2.125	3.20	2.50
65 x 50	66.7 x 54.0	81	64
3 x 2	3.125 x 2.125	3.50	2.50
80 x 50	79.4 x 54.0	89	64
3 x 2½	3.125 x 2.625	3.50	2.50
80 x 65	79.4 x 66.7	89	64
4 x 2	4.125 x 2.125	4.25	3.00
100 x 50	104.8 x 54.0	108	76
4 x 2½	4.125 x 2.625	4.25	3.00
100 x 65	104.8 x 66.7	108	76
4 x 3	4.125 x 3.125	4.25	3.00
100 x 80	104.8 x 79.4	108	76
5 x 3	5.125 x 3.125	5.94	3.50
125 x 80	130.2 x 79.4	151	89
5 x 4	5.125 x 4.125	5.94	3.50
125 x 100	130.2 x 104.8	151	89
6 x 2½	6.125 x 2.625	6.94	4.00
150 x 65	155.6 x 66.7	176	102
6 x 3	6.125 x 3.125	6.94	4.00
150 x 80	155.6 x 79.4	176	102
6 x 4	6.125 x 4.125	6.94	4.00
150 x 100	155.6 x 104.8	176	102
6 x 5	6.125 x 5.125	6.94	4.00
150 x 125	155.6 x 130.2	176	102

Model C26 Reducing Tee
C52 Concentric Reducer

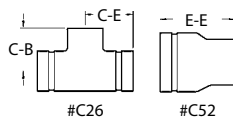

Nominal Size in / mm	# C26		#C52 E-E in / mm
	C-E in / mm	C-B in / mm	
2 x 2 x ¾	2.20	2.00	---
50 x 50 x 20	56	51	---
2 x 2 x 1	2.33	2.16	2.70
50 x 50 x 25	59	55	69
2 x 2 x 1¼	2.48	2.22	3.00
50 x 50 x 32	63	56	76
2 x 2 x 1½	2.60	2.34	2.94
50 x 50 x 40	66	59	75
2½ x 2½ x ¾	2.28	2.25	---
65 x 65 x 20	58	57	---
2½ x 2½ x 1	2.40	2.41	3.25
65 x 65 x 25	61	61	83
2½ x 2½ x 1¼	2.52	2.47	3.52
65 x 65 x 32	64	63	89
2½ x 2½ x 1½	2.70	2.59	3.45
65 x 65 x 40	69	66	88
2½ x 2½ x 2	2.95	2.84	3.30
65 x 65 x 50	75	72	84
3 x 3 x ¾	2.44	2.50	---
80 x 80 x 20	62	64	---
3 x 3 x 1	2.54	2.60	---
80 x 80 x 25	65	66	---
3 x 3 x 1¼	2.63	2.72	---
80 x 80 x 32	67	69	---
3 x 3 x 1½	2.85	2.84	3.68
80 x 80 x 40	72	72	93
3 x 3 x 2	3.11	3.09	4.10
80 x 80 x 50	79	78	104
4 x 4 x ¾	3.00	3.00	---
100 x 100 x 20	76	76	---
4 x 4 x 1	3.10	3.16	---
100 x 100 x 25	79	80	---
4 x 4 x 1¼	3.25	3.22	---
100 x 100 x 32	83	82	---
4 x 4 x 1½	3.35	3.34	---
100 x 100 x 40	85	85	---
4 x 4 x 2	3.62	3.59	4.75
100 x 100 x 50	92	91	121

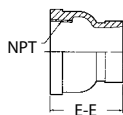
Model C55 Transition Adapter (FT x GR)

#C55

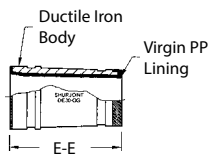
Nominal Size IPS (NPT) x CTS (GRV) in / mm	#C55 E-E in / mm
1½ x 2	2.50
40 x 50	63
2 x 2	2.50
50 x 50	63
2½ x 2½	2.75
65 x 65	70
3 x 3	3.00
80 x 80	76

Model DE30-GG Dielectric Transition Fitting (IPS x CTS)

Nominal Size in / mm	#DE30-GG E-E in / mm
2	4.00
50	102
2½	4.00
65	102
3	4.00
80	102
4	4.00
100	102
5	4.00
125	102
6	4.00
150	102
8	4.00
200	102

AWWA Ductile Iron Series

Model A505 Coupling
 A507 Transition Coupling
 A512 Flange Adapter

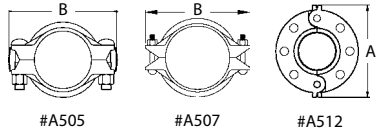

Nominal Size in / mm	Pipe O.D. in / mm	#A505 B in / mm	#A507 B in / mm	#A512 A in / mm
3	3.96	7.64	7.38	7.50
80	100.6	194	187	190
4	4.80	8.70	9.00	9.00
100	121.9	221	229	229
6	6.90	10.43	11.13	11.00
150	175.3	265	283	279
8	9.05	13.94	13.88	13.50
200	229.9	354	353	343
10	11.10	16.00	16.50	16.00
250	281.9	406	419	406
12	13.20	18.90	18.94	19.00
300	335.3	480	481	483
14	15.30	20.87	---	---
350	388.6	530	---	---
16	17.40	22.78	---	---
400	442.0	604	---	---
18	19.50	26.00	---	---
450	495.3	660	---	---
20	21.60	28.35	---	---
500	548.6	720	---	---
24	25.80	33.07	---	---
600	655.3	840	---	---

Model A10 90° Elbow
 A11 45° Elbow
 A12 22½° Elbow

Model A13 11¼° Elbow
 A20 Tee
 A60 Cap



#A10



#A11



#A12



#A13

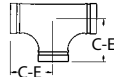

#A20

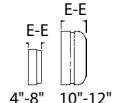

#A60

Nominal Size in / mm	Pipe O.D. in / mm	#A10 C-E in / mm	#A11 C-E in / mm	#A12 C-E in / mm	#A13 C-E in / mm	#A20 C-E in / mm	#A60 E-E in / mm
3	3.96	5.50	3.00	3.00	3.00	5.50	1.6
80	100.6	140	76	76	76	140	2.9
4	4.80	6.50	4.00	4.00	4.00	6.50	1.16
100	121.9	165	102	102	102	165	29
6	6.90	8.00	5.00	5.00	5.00	8.00	1.16
150	175.3	203	127	127	127	203	29
8	9.05	9.00	5.50	5.50	5.50	9.00	1.34
200	229.9	229	140	140	140	229	34
10	11.10	11.00	6.50	6.50	6.50	11.00	1.53
250	281.9	279	165	165	165	279	39
12	13.20	12.00	7.50	7.50	7.50	12.00	1.53
300	335.3	305	191	191	191	305	39

Model A25 Reducing Tee
 A50 Concentric Reducer
 A10R 90° Reducing Elbow



#A25

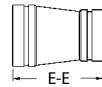

#A50

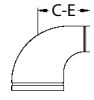

#A10R

AWWA D. I. Pipe		#A25 C-E in / mm	#A50 E-E in / mm	#A10R C-E in / mm
Nominal Size in / mm	Pipe O.D. in / mm			
4 x 3	4.80 x 3.96	6.50	7.00	6.50
100 x 80	121.9 x 100.6	165	178	165
6 x 4	6.90 x 4.80	8.00	9.00	8.00
150 x 100	175.3 x 121.9	203	229	203
8 x 4	9.05 x 4.80	9.00	11.00	9.00
200 x 100	229.9 x 121.9	229	279	229
8 x 6	9.05 x 6.90	9.00	11.00	9.00
200 x 150	229.9 x 175.3	229	279	229
10 x 4	11.10 x 4.80	11.00	12.00	-
250 x 100	281.9 x 121.9	279	305	-
10 x 6	11.10 x 6.90	11.00	12.00	11.00
250 x 150	281.9 x 175.3	279	305	279
10 x 8	11.10 x 9.05	11.00	12.00	11.00
250 x 200	281.9 x 229.9	279	305	279
12 x 4	13.20 x 4.80	12.00	14.00	-
300 x 100	335.3 x 121.9	305	356	-
12 x 6	13.20 x 6.90	12.00	14.00	12.00
300 x 150	335.3 x 175.3	305	356	305
12 x 8	13.20 x 9.05	12.00	14.00	12.00
300 x 200	335.3 x 229.9	305	356	305
12 x 10	13.20 x 11.10	12.00	14.00	12.00
300 x 250	335.3 x 281.9	305	356	305

HELPFUL INFORMATION

Metric/Imperial Conversion Chart

Decimal Equivalents of Fractions (inches)

Minutes Converted to Decimals of a Degree

Water Pressure to Feet-of-Head

Feet-of-Head of Water to Pressure

Pipe Sizes & Wall Thickness

Metric/Imperial Conversion Chart

The below chart is provided as a guide for converting metric and imperial and measurements.

Convert Imperial to Metric		
To Change	To	Multiple By
Inches (in)	MilliMetres (mm)	25.4
Feet (ft)	Meters (m)	0.3048
Pounds (lb)	Kilogrammes (kg)	0.4536
Ounces (oz)	Grammes (g)	28.35
Pressure (psi)	Kilopascals (kPa)	6.894
Pressure (psi)	Bar	0.069
End Load (lb)	Newtons (N)	4.45
Torque (lb/ft)	Newton Metres (N•m)	1.356
Temp. (°F)	Celsius (°C)	$(F - 32) \div 1.8$
Horsepower (hp)	Watts (w)	745.7
Gal. per Min. (gpm)	Litres per Min. (L/M)	3.785
10 ³ Gal. per Min. (gpm)	Cubic Metres per Min. (m ³ /m)	3.7865

Convert Metric to Imperial		
To Change	To	Multiple By
MilliMetres (mm)	Inches (in)	0.03937
Meters (m)	Feet (ft)	3.281
Kilogrammes (kg)	Pounds (lb)	2.205
Grammes (g)	Ounces (oz)	0.03527
Kilopascals (kPa)	Pressure (psi)	0.145
Bar	Pressure (psi)	14.5
Newtons (N)	End Load (lb)	0.2248
Newton Metres (N•m)	Torque (lb/ft)	0.738
Celsius (°C)	Temp. (°F)	$(C+17.78) \times 1.8$
Watts (w)	Horsepower (hp)	1.341×10^{-3}
Litres per Min. (L/M)	Gal. per Min. (gpm)	0.2642
Cubic Metres per Min. (m ³ /m)	10 ³ Gal. per Min. (gpm)	264.2

Decimal Equivalents of Fractions (inches)

Fraction in inches	Decimal Equivalent inches	Decimal Equivalent millimeters
1/64	0.016	0,397
1/32	0.031	0,794
3/64	0.047	1,191
1/16	0.063	1,588
5/64	0.078	1,984
3/32	0.094	2,381
7/64	0.109	2,778
1/8	0.125	3,175
9/64	0.141	3,572
5/32	0.156	3,969
11/64	0.172	4,366
3/16	0.188	4,763
13/64	0.203	5,159
7/32	0.219	5,556
15/64	0.234	5,953
1/4	0.250	6,350
17/64	0.266	6,747
9/32	0.281	7,144
19/64	0.297	7,541
5/16	0.313	7,938
21/64	0.328	8,334
1/3	0.333	8,467
11/32	0.344	8,731
23/64	0.359	9,128
3/8	0.375	9,525
25/64	0.391	9,922
13/32	0.406	10,319
27/64	0.422	10,716
7/16	0.438	11,113
29/64	0.453	11,509
15/32	0.469	11,906
1/2	0.500	12,700

Fraction in inches	Decimal Equivalent inches	Decimal Equivalent millimeters
33/64	0.516	13,097
17/32	0.531	13,494
35/64	0.547	13,891
9/16	0.563	14,288
37/64	0.578	14,684
19/32	0.594	15,081
39/64	0.609	15,478
5/8	0.625	15,875
41/64	0.641	16,272
21/32	0.656	16,669
43/64	0.672	17,066
11/16	0.688	17,463
45/64	0.703	17,859
23/32	0.719	18,256
47/64	0.734	18,653
3/4	0.750	19,050
49/64	0.766	19,447
25/32	0.781	19,844
51/64	0.797	20,241
13/16	0.813	20,638
53/64	0.828	21,034
27/32	0.844	21,431
55/64	0.859	21,828
7/8	0.875	22,225
57/64	0.891	22,622
29/32	0.906	23,019
59/64	0.922	23,416
15/16	0.938	23,813
61/64	0.953	24,209
31/32	0.969	24,606
63/64	0.984	25,003
1	1.000	25,400

Minutes Converted to Decimals of a Degree

Min.	Deg.
1	0.0166
2	0.0333
3	0.0500
4	0.0666
5	0.0833
6	0.1000
7	0.1166
8	0.1333
9	0.1500
10	0.1666
11	0.1833
12	0.2000
13	0.2166
14	0.2333
15	0.2500
16	0.2666
17	0.2833
18	0.3000
19	0.3166
20	0.3333
21	0.3500
22	0.3666
23	0.3833
24	0.4000
25	0.4166
26	0.4333
27	0.4500
28	0.4666
29	0.4833
30	0.5000

Min.	Deg.
31	0.5166
32	0.5333
33	0.5500
34	0.5666
35	0.5833
36	0.6000
37	0.6166
38	0.6333
39	0.6500
40	0.6666
41	0.6833
42	0.7000
43	0.7166
44	0.7333
45	0.7500
46	0.7666
47	0.7833
48	0.8000
49	0.8166
50	0.8333
51	0.8500
52	0.8666
53	0.8833
54	0.9000
55	0.9166
56	0.9333
57	0.9500
58	0.9666
59	0.9833
60	1.0000

Water Pressure to Feet-of-Head

Pounds Per Square Inch	Feet of Head
1	2.31
2	4.62
3	6.93
4	9.24
5	11.54
6	13.85
7	16.16
8	18.47
9	20.78
10	23.09
15	34.63
20	46.18
25	57.72
30	69.27
40	92.36
50	115.45
60	138.54
70	161.63
80	184.72
90	207.81
100	230.90
110	253.93
120	277.07
130	300.16
140	323.25
150	346.34
160	369.43
170	392.52
180	415.61
200	461.78
250	577.24
300	692.69
350	808.13
400	922.58
500	1154.48
600	1385.39
700	1616.30
800	1847.20
900	2078.10
1000	2309.00

Feet-of-Head of Water to Pressure

Feet of Head	Pounds Per Square Inch
1	0.43
2	0.87
3	1.30
4	1.73
5	2.17
6	2.60
7	3.03
8	3.46
9	3.90
10	4.33
15	6.50
20	8.66
25	10.83
30	12.99
40	17.32
50	21.65
60	25.99
70	30.32
80	34.65
90	38.98
100	43.31
110	47.64
120	51.97
130	56.30
140	60.63
150	64.96
160	69.29
170	73.63
180	77.96
200	86.62
250	108.27
300	129.93
350	151.58
400	173.24
500	216.55
600	259.85
700	303.16
800	346.47
900	389.78
1000	433.00

Pipe Sizes & Wall Thickness

ANSI Commercial Pipe Sizes Chart

Based on ASME/ANSI B36.10, standard for Welded and Seamless Wrought Steel Pipe and ASME/ANSI B36.19.

Pipe Size Nominal Diameter in / mm	Actual Outside Diameter in / mm	Nominal Wall – inches/millimeters					
		Sch. 5S in / mm	Sch. 10S in / mm	Sch. 10 in / mm	Sch. 20 in / mm	Sch. 30 in / mm	Std. in / mm
½	0.405	-	0.049	-	-	-	0.068
6	10,3	-	1,2	-	-	-	1,7
¼	0.540	-	0.065	-	-	-	0.088
8	13,7	-	1,7	-	-	-	2,2
3/8	0.675	-	0.065	-	-	-	0.091
10	17,1	-	1,7	-	-	-	2,3
½	0.840	0.065	0.083	-	-	-	0.109
15	21,3	1,7	2,1	-	-	-	2,8
¾	1.050	0.065	0.083	-	-	-	0.113
20	26,9	1,7	2,1	-	-	-	2,9
1	1.315	0.065	0.109	-	-	-	0.133
25	33,7	1,7	2,8	-	-	-	3,4
1¼	1.660	0.065	0.109	-	-	-	0.140
32	42,4	1,7	2,8	-	-	-	3,6
1½	1.900	0.065	0.109	-	-	-	0.145
40	48,3	1,7	2,8	-	-	-	3,7
2	2.375	0.065	0.109	-	-	-	0.154
50	60,3	1,7	2,8	-	-	-	3,9
2½	2.875	0.083	0.120	-	-	-	0.203
65	73,0	2,1	3,0	-	-	-	5,2
3	3.500	0.083	0.120	-	-	-	0.216
80	88,9	2,1	3,0	-	-	-	5,5
3½	4.000	0.083	0.120	-	-	-	0.226
90	101,6	2,1	3,0	-	-	-	5,7
4	4.500	0.083	0.120	-	-	-	0.237
100	114,3	2,1	3,0	-	-	-	6,0
5	5.563	0.109	0.134	-	-	-	0.258
125	141,3	2,8	3,4	-	-	-	6,6
6	6.625	0.109	0.134	-	-	-	0.280
150	168,3	2,8	3,4	-	-	-	7,1
8	8.625	0.109	0.148	-	0.250	0.277	0.322
200	219,1	2,8	3,8	-	6,4	7,0	8,2
10	10.750	0.134	0.165	-	0.250	0.307	0.365
250	273,0	3,4	4,2	-	6,4	7,8	9,3
12	12.750	0.156	0.180	-	0.250	0.330	0.375
300	323,9	4,0	4,6	-	6,4	8,4	9,5

Thickness – inches/millimeters								
Sch. 40 in / mm	Sch. 60 in / mm	Extra Heavy in / mm	Sch. 80 in / mm	Sch. 100 in / mm	Sch. 120 in / mm	Sch. 140 in / mm	Sch. 160 in / mm	XX Heavy in / mm
0.068	-	0.095	0.095	-	-	-	-	-
1,7	-	2,4	2,4	-	-	-	-	-
0.088	-	0.119	0.119	-	-	-	-	-
2,2	-	3,0	3,0	-	-	-	-	-
0.091	-	0.126	0.126	-	-	-	-	-
2,3	-	3,2	3,2	-	-	-	-	-
0.109	-	0.147	0.147	-	-	-	0.188	0.294
2,8	-	3,7	3,7	-	-	-	4,8	7,5
0.113	-	0.154	0.154	-	-	-	0.219	0.308
2,9	-	3,9	3,9	-	-	-	5,6	7,8
0.133	-	0.179	0.179	-	-	-	0.250	0.358
3,4	-	4,5	4,5	-	-	-	6,4	9,1
0.140	-	0.191	0.191	-	-	-	0.250	0.382
3,6	-	4,9	4,9	-	-	-	6,4	9,7
0.145	-	0.200	0.200	-	-	-	0.281	0.400
3,7	-	5,1	5,1	-	-	-	7,1	10,2
0.154	-	0.218	0.218	-	-	-	0.344	0.436
3,9	-	5,5	5,5	-	-	-	8,7	11,1
0.203	-	0.276	0.276	-	-	-	0.375	0.552
5,2	-	7,0	7,0	-	-	-	9,5	14,0
0.216	-	0.300	0.300	-	-	-	0.438	0.600
5,5	-	7,6	7,6	-	-	-	11,1	15,2
0.226	-	0.318	0.318	-	-	-	-	-
5,7	-	8,1	8,1	-	-	-	-	-
0.237	-	0.337	0.337	-	0.438	-	0.531	0.674
6,0	-	8,6	8,6	-	11,1	-	13,5	17,1
0.258	-	0.375	0.375	-	0.500	-	0.625	0.750
6,6	-	9,5	9,5	-	12,7	-	15,9	19,1
0.280	-	0.432	0.432	-	0.562	-	0.719	0.864
7,1	-	11,0	11,0	-	14,3	-	18,3	21,9
0.322	0.406	0.500	0.500	0.594	0.719	0.812	0.906	0.875
8,2	10,3	12,7	12,7	15,1	18,3	20,6	23,0	22,2
0.365	0.500	0.500	0.594	0.719	0.844	1.000	1.125	1.000
9,3	12,7	12,7	15,1	18,3	21,4	25,4	28,6	25,4
0.406	0.562	0.500	0.688	0.844	1.000	1.125	1.312	1.000
10,3	14,3	12,7	17,5	21,4	25,4	28,6	33,3	25,4

Continued on next page

ANSI Commercial Pipe Sizes Chart

Pipe Size Nominal Diameter in / mm	Actual Outside Diameter in / mm	Nominal Wall – inches/millimeters					
		Sch. 5S in / mm	Sch. 10S in / mm	Sch. 10 in / mm	Sch. 20 in / mm	Sch. 30 in / mm	Std. in / mm
14	14.000	0.156	0.188	0.250	0.312	0.375	0.375
	355,6	4,0	4,8	6,4	7,9	9,5	9,5
16	16.000	0.165	0.188	0.250	0.312	0.375	0.375
	406,4	4,2	4,8	6,4	7,9	9,5	9,5
18	18.000	0.165	0.188	0.250	0.312	0.438	0.375
	457,0	4,2	4,8	6,4	7,9	11,1	9,5
20	20.000	0.188	0.218	0.250	0.375	0.500	0.375
	508,0	4,8	5,5	6,4	9,5	12,7	9,5
22	22.000	0.188	0.218	0.250	0.375	0.500	0.375
	559,0	4,8	5,5	6,4	9,5	12,7	9,5
24	24.000	0.218	0.250	0.250	0.375	0.562	0.375
	610,0	5,5	6,4	6,4	9,5	14,3	9,5
26	26.000	-	-	0.312	0.500	-	0.375
	660,4	-	-	7,9	12,7	-	9,5
28	28.000	-	-	0.312	0.500	0.625	0.375
	711,0	-	-	7,9	12,7	15,9	9,5
30	30.000	0.250	0.312	0.312	0.500	0.625	0.375
	762,0	6,4	7,9	7,9	12,7	15,9	9,5
32	32.000	-	-	0.312	0.500	0.625	0.375
	813,0	-	-	7,9	12,7	15,9	9,5
34	34.000	-	-	0.312	0.500	0.625	0.375
	863,6	-	-	7,9	12,7	15,9	9,5
36	36.000	-	-	0.312	0.500	0.625	0.375
	914,0	-	-	7,9	12,7	15,9	9,5
42	42.000	-	-	-	0.375	-	-
	1067,0	-	-	-	9,5	-	-

Thickness – inches/millimeters								
Sch. 40 in / mm	Sch. 60 in / mm	Extra Heavy in / mm	Sch. 80 in / mm	Sch. 100 in / mm	Sch. 120 in / mm	Sch. 140 in / mm	Sch. 160 in / mm	XX Heavy in / mm
0.438	0.594	0.500	0.688	0.938	1.094	1.250	1.406	-
11,1	15,1	12,7	17,5	23,8	27,8	31,8	35,7	-
0.500	0.656	0.500	0.750	1.031	1.219	1.438	1.594	-
12,7	16,7	12,7	19,1	26,2	31,0	36,5	40,5	-
0.562	0.750	0.500	0.844	1.156	1.375	1.562	1.781	-
14,3	19,1	12,7	21,4	29,4	34,9	39,7	45,2	-
0.594	0.812	0.500	0.938	1.281	1.500	1.750	1.969	-
15,1	20,6	12,7	23,8	32,5	38,1	44,5	50,0	-
-	0.875	0.500	1.031	1.375	1.625	1.875	2.125	-
-	22,2	12,7	26,2	34,9	41,3	47,6	54,0	-
0.688	0.969	0.500	1.125	1.531	1.812	2.062	2.344	-
17,5	24,6	12,7	28,6	38,9	46,0	52,4	59,5	-
-	-	0.500	1.218	-	-	-	-	-
-	-	12,7	30,9	-	-	-	-	-
-	-	0.500	-	-	-	-	-	-
-	-	12,7	-	-	-	-	-	-
-	-	0.500	-	-	-	-	-	-
-	-	12,7	-	-	-	-	-	-
0.688	-	0.500	-	-	-	-	-	-
17,5	-	12,7	-	-	-	-	-	-
0.688	-	0.500	-	-	-	-	-	-
17,5	-	12,7	-	-	-	-	-	-
0.750	-	0.500	-	-	-	-	-	-
19,1	-	12,7	-	-	-	-	-	-
-	-	0.500	-	-	-	-	-	-
-	-	12,7	-	-	-	-	-	-

Pipe Dimensions to AS 1074

Unit: mm

Class Nom. Size	Medium / Heavy		Medium	Heavy
	Pipe O.D.			
	Min.	Max		
DN 8	13.3	13.9	2.3	2.9
DN 10	16.8	17.4	2.3	2.9
DN 15	21.1	21.7	2.6	3.2
DN 20	26.6	27.2	2.6	3.2
DN 25	33.4	34.2	3.2	4.0
DN 32	42.1	42.9	3.2	4.0
DN 40	48.0	48.8	3.2	4.0
DN 50	59.8	60.8	3.6	4.5
DN 65	75.4	76.6	3.6	4.5
DN 80	88.1	89.5	4.0	5.0
DN 100	113.3	114.9	4.5	5.4
DN 125	138.7	140.6	5.0	5.4
DN 150	164.1	166.1	5.0	5.4

Pipe Dimensions to EN 10255:2004

Unit: mm

Class		Medium / Heavy		Medium	Heavy
DN	Specified O.D.	Pipe O.D.			
		Min.	Max.		
6	10,2	9,8	10,6	2,0	2,6
8	13,5	13,2	14,0	2,3	2,9
10	17,2	16,7	17,5	2,3	2,9
15	21,3	21,0	21,8	2,6	3,2
20	26,9	26,5	27,3	2,6	3,2
25	33,7	33,3	34,2	3,2	4,0
32	42,4	42,0	42,9	3,2	4,0
40	48,3	47,9	48,8	3,2	4,0
50	60,3	59,7	60,8	3,6	4,5
65	76,1	75,3	76,6	3,6	4,5
80	88,9	88,0	89,5	4,0	5,0
100	114,3	113,1	115,0	4,5	5,4
125	139,7	138,5	140,8	5,0	5,4
150	165,1	163,9	166,5	5,0	5,4

Copper Tubing Sizes & Wall Thicknesses

Copper Tube: TYPE K

Nominal Size	Nominal Dimensions, inches		
	Outside Diameter	Inside Diameter	Wall Thickness
¾	0.875	0.745	0.065
1	1.125	0.995	0.065
1¼	1.375	1.245	0.065
1½	1.625	1.481	0.072
2	2.125	1.959	0.083
2½	2.625	2.435	0.095
3	3.125	2.907	0.109
3½	3.625	3.385	0.120
4	4.125	3.857	0.134
5	5.125	4.805	0.160
6	6.125	5.741	0.192
8	8.125	7.583	0.271

Copper Tube: TYPE M

Nominal Size	Nominal Dimensions, inches		
	Outside Diameter	Inside Diameter	Wall Thickness
¾	0.875	0.811	0.032
1	1.125	1.055	0.035
1¼	1.375	1.291	0.042
1½	1.625	1.527	0.049
2	2.125	2.009	0.058
2½	2.625	2.495	0.065
3	3.125	2.981	0.072
3½	3.625	3.459	0.083
4	4.125	3.935	0.095
5	5.125	4.907	0.109
6	6.125	5.881	0.122
8	8.125	7.785	0.170
10	10.125	9.701	0.212
12	12.125	11.617	0.254

Copper Tube: TYPE L

Nominal Size	Nominal Dimensions, inches		
	Outside Diameter	Inside Diameter	Wall Thickness
¾	0.875	0.785	0.045
1	1.125	1.025	0.050
1¼	1.375	1.265	0.055
1½	1.625	1.505	0.060
2	2.125	1.985	0.070
2½	2.625	2.465	0.080
3	3.125	2.945	0.090
3½	3.625	3.425	0.100
4	4.125	3.905	0.110
5	5.125	4.875	0.125
6	6.125	5.845	0.140
8	8.125	7.725	0.200
10	10.125	9.625	0.250
12	12.125	11.565	0.280

Copper Tube: TYPE DWV

Nominal or standard Size, inches	Nominal Dimensions, inches		
	Outside Diameter	Inside Diameter	Wall Thickness
1¼	1.375	1.295	0.040
1½	1.625	1.541	0.042
2	2.125	2.041	0.042
3	3.125	3.035	0.045
4	4.125	4.009	0.058
5	5.125	4.981	0.072
6	6.125	5.959	0.083
8	8.125	7.907	0.109

BOLT & SOCKET SIZE: INCH

For Shurjoint Grooved Couplings and Mechanical Tees

Pipe Size		Z05 / K9		Z07 / 7771		7705		7707	
inch	Actual O.D.	Bolt Size	Socket Size	Bolt Size	Socket Size	Bolt Size	Socket Size	Bolt Size	Socket Size
¾	1.050							¾	1 ¹ / ₁₆
1	1.315								
1¼	1.660	¾	1 ¹ / ₁₆	¾	1 ¹ / ₁₆	¾	1 ¹ / ₁₆	¾	1 ¹ / ₁₆
1½	1.900	¾	1 ¹ / ₁₆	¾	1 ¹ / ₁₆	¾	1 ¹ / ₁₆	½	¾
2	2.375	¾	1 ¹ / ₁₆	¾	1 ¹ / ₁₆	¾	1 ¹ / ₁₆	½	¾
2½	2.875	¾	1 ¹ / ₁₆	¾	1 ¹ / ₁₆	¾	1 ¹ / ₁₆	½	¾
76.1 mm	3.000	¾	1 ¹ / ₁₆	¾	1 ¹ / ₁₆	¾	1 ¹ / ₁₆	½	¾
3	3.500	¾	1 ¹ / ₁₆	½	¾	½	¾	½	¾
101.6 mm	4.000					½	¾		
108.0 mm	4.250								
4	4.500	¾	1 ¹ / ₁₆	½	¾	½	¾	¾	1 ¹ / ₁₆
4	4.500								
133.0 mm	5.250								
139.7 mm	5.500	½	¾	¾	1 ¹ / ₁₆	¾	1 ¹ / ₁₆	¾	1 ¹ / ₁₆
5	5.563	½	¾	¾	1 ¹ / ₁₆	¾	1 ¹ / ₁₆	¾	1 ¹ / ₁₆
159.0 mm	6.250								
165.1 mm	6.500	½	¾	¾	1 ¹ / ₁₆	¾	1 ¹ / ₁₆	¾	1¼
6	6.625	½	¾	¾	1 ¹ / ₁₆	¾	1 ¹ / ₁₆	¾	1¼
8	8.625	¾	1 ¹ / ₁₆	¾ (7771)	1 ¹ / ₁₆	¾	1 ¹ / ₁₆	¾	1¼
8	8.625			¾ (Z07)	1¼				
10	10.750			¾ (7771)	1¼	¾	1¼	¾	1 ⁷ / ₁₆
10	10.750			¾ (Z07)	1 ⁷ / ₁₆				
12	12.750			¾	1 ⁷ / ₁₆	¾	1 ⁷ / ₁₆	¾	1 ⁷ / ₁₆
14	14.000			¾	1 ⁷ / ₁₆			¾	1 ⁷ / ₁₆
16	16.000			¾	1 ⁷ / ₁₆			1	1 ⁵ / ₈
18	18.000			¾	1 ⁷ / ₁₆			1	1 ⁵ / ₈
20	20.000			1	1 ⁵ / ₈			1	1 ⁵ / ₈
22	22.000			1	1 ⁵ / ₈			1	1 ⁵ / ₈
24	24.000			1	1 ⁵ / ₈			1	1 ⁵ / ₈

Note 1: 7721 / 7722 Mechanical tee 4" x 3" is supplied with ¾" bolts.

Note 2: 7771 Rigid coupling 8" is supplied with ¾" bolts and Z07 8" with ¾" bolts.

Note 3: 7771 Rigid coupling 10" is supplied with ¾" bolts and Z07 10" with ¾" bolts.

XH-70EP		79		7706		7721 / 7722		723		Pipe Size
Bolt Size	Socket Size	Bolt Size	Socket Size	Bolt Size	Socket Size	Bolt Size	Socket Size	Bolt Size	Socket Size	inch
										¾
										1
								¾	11/16	1¼
				¾	11/16			¾	11/16	1½
⅝	11/16	⅝	11/16	¾	11/16	¾	11/16	¾	11/16	2
⅝	11/16	⅝	11/16	¾	11/16	½	⅞	¾	11/16	2½
										76.1 mm
⅝	11/16	¾	1¼	½	⅞	½	⅞			3
										101.6 mm
										108.0 mm
¾	1¼	¾	1¼	½	⅞	½	⅞			4
						⅝	11/16			4
										133.0 mm
										139.7 mm
				⅝	11/16	⅝	11/16			5
										159.0 mm
										165.1 mm
⅞	17/16	⅞	17/16	⅝	11/16	⅝	11/16			6
1	1⅝	¾	1¼	¾	1¼	¾	1¼			8
										8
1	1⅝	⅞	17/16							10
										10
1	1⅝	1	1⅝							12
		1	1⅝							14
		1	1⅝							16
										18
										20
										22
										24

Copper Tubing Series (inch)

Pipe Size		C305		C307		C306	
inch	Actual O.D. (U.S. Standard Copper Tubing)	Bolt Size	Socket Size	Bolt Size	Socket Size	Bolt Size	Socket Size
2	2.125	$\frac{3}{8}$	$1\frac{1}{16}$	$\frac{3}{8}$	$1\frac{1}{16}$		
2½	2.625	$\frac{3}{8}$	$1\frac{1}{16}$	$\frac{3}{8}$	$1\frac{1}{16}$	$\frac{1}{2}$	$\frac{7}{8}$
3	3.125	$\frac{1}{2}$	$\frac{3}{8}$	$\frac{1}{2}$	$\frac{3}{8}$	$\frac{1}{2}$	$\frac{7}{8}$
4	4.125	$\frac{1}{2}$	$\frac{3}{8}$	$\frac{1}{2}$	$\frac{3}{8}$	$\frac{1}{2}$	$\frac{7}{8}$
5	5.125	$\frac{5}{8}$	$1\frac{1}{16}$			$\frac{5}{8}$	$1\frac{1}{16}$
6	6.125	$\frac{5}{8}$	$1\frac{1}{16}$			$\frac{5}{8}$	$1\frac{1}{16}$
8	8.125	$\frac{5}{8}$	$1\frac{1}{16}$				

Stainless Steel Series (inch)

Pipe Size		SS-7		SS-8		SS-7X		SS-8X	
inch	Actual O.D.	Bolt Size	Socket Size	Bolt Size	Socket Size	Bolt Size	Socket Size	Bolt Size	Socket Size
$\frac{3}{4}$	1.050							$\frac{3}{8}$	$1\frac{1}{16}$
1	1.315			$\frac{5}{16}$				$\frac{3}{8}$	$1\frac{1}{16}$
1¼	1.660	$\frac{3}{8}$	$1\frac{1}{16}$	$\frac{5}{16}$				$\frac{3}{8}$	$1\frac{1}{16}$
1½	1.900	$\frac{3}{8}$	$1\frac{1}{16}$	$\frac{5}{16}$				$\frac{3}{8}$	$1\frac{1}{16}$
2	2.375	$\frac{3}{8}$	$1\frac{1}{16}$	$\frac{3}{8}$	$1\frac{1}{16}$			$\frac{3}{8}$	$1\frac{1}{16}$
2½	2.875	$\frac{3}{8}$	$1\frac{1}{16}$	$\frac{3}{8}$	$1\frac{1}{16}$			$\frac{3}{8}$	$1\frac{1}{16}$
2½	3.000	$\frac{3}{8}$	$1\frac{1}{16}$	$\frac{3}{8}$	$1\frac{1}{16}$				
3	3.500	$\frac{3}{8}$	$1\frac{1}{16}$	$\frac{3}{8}$	$1\frac{1}{16}$			$\frac{1}{2}$	$\frac{7}{8}$
4	4.500	$\frac{1}{2}$	$1\frac{1}{16}$	$\frac{1}{2}$	$\frac{7}{8}$			$\frac{1}{2}$	$\frac{7}{8}$
5	5.500	$\frac{1}{2}$	$\frac{7}{8}$						
5	5.563	$\frac{1}{2}$	$\frac{7}{8}$	$\frac{1}{2}$	$\frac{7}{8}$			$\frac{5}{8}$	$1\frac{1}{16}$
6	6.500	$\frac{1}{2}$	$\frac{7}{8}$	$\frac{1}{2}$	$\frac{7}{8}$				
6	6.625	$\frac{1}{2}$	$\frac{7}{8}$	$\frac{1}{2}$	$\frac{7}{8}$			$\frac{5}{8}$	$1\frac{1}{16}$
8	8.625	$\frac{5}{8}$	$1\frac{1}{16}$	$\frac{5}{8}$	$1\frac{1}{16}$			$\frac{3}{4}$	$1\frac{1}{4}$
10	10.750					$\frac{7}{8}$	$1\frac{7}{16}$		
12	12.750					$\frac{7}{8}$	$1\frac{7}{16}$		
14	14.000					$\frac{7}{8}$	$1\frac{7}{16}$		
16	16.000					$\frac{5}{8}$	$1\frac{1}{16}$		
18	18.000					$\frac{5}{8}$	$1\frac{1}{16}$		
20	20.000					$\frac{3}{4}$	$1\frac{1}{4}$		
22	22.000					$\frac{3}{4}$	$1\frac{1}{4}$		
24	24.000					$\frac{3}{4}$	$1\frac{1}{4}$		

AWWA Series (inch)

Pipe Size		A505		A507	
inch	Actual O.D.	Bolt Size	Socket Size	Bolt Size	Socket Size
3	3.96	½	¾	½	¾
4	4.80	⅝	1 ¹ / ₁₆	⅝	1 ¹ / ₁₆
6	6.90	⅝	1 ¹ / ₁₆	⅝	1 ¹ / ₁₆
8	9.05	¾	1¼	¾	1¼
10	11.10	¾	1¼	¾	1 ⁷ / ₁₆
12	13.20	¾	1 ⁷ / ₁₆	¾	1 ⁷ / ₁₆
14	15.30	1	1 ⁵ / ₈		
16	17.40	1	1 ⁵ / ₈		
18	19.50	1	1 ⁵ / ₈		
20	21.60	1 ¹ / ₈			
24	25.80	1 ¹ / ₈			

HDPE Series (inch)

Pipe Size		H305		H307	
inch	Actual O.D.	Bolt Size	Socket Size	Bolt Size	Socket Size
2	2.375	½	¾	½	¾
3	3.500	½	¾	½	¾
4	4.500	½	¾	½	¾
6	6.625	⅝	1 ¹ / ₁₆	⅝	1 ¹ / ₁₆
8	8.625	⅝	1 ¹ / ₁₆	⅝	1 ¹ / ₁₆
10	10.750	¾	1¼	¾	1¼
12	12.750	¾	1¼	¾	1¼
14	14.000	1	1 ⁵ / ₈		
16	16.000	1	1 ⁵ / ₈		
18	18.000	1	1 ⁵ / ₈		
20	20.000	1	1 ⁵ / ₈		

BOLT & SOCKET SIZE: METRIC (MM)

For Shurjoint Grooved Couplings and Mechanical Tees

Nominal Size	Pipe O.D.	Z05 / K9		Z07 / 7771		7705		7707	
		Bolt Size	Socket Size	Bolt Size	Socket Size	Bolt Size	Socket Size	Bolt Size	Socket Size
20	26.7							M10	17
25	33.4					M10	17	M10	17
32	42.2	M10	17	M10	17	M10	17	M12	19
40	48.3	M10	17	M10	17	M10	17	M12	19
50	60.3	M10	17	M10	17	M10	17	M12	19
65	73.0	M10	17	M10	17	M10	17	M12	19
65	76.1	M10	17	M10	17	M10	17	M12	19
80	88.9	M10	17	M12	19	M12	19	M12	19
90	101.6					M12	19		
100	114.3	M10	17	M12	19	M12	19	M16	24
125	139.7	M12	19	M16	24	M16	24	M16	24
125	141.3	M12	19	M16	24	M16	24	M16	24
150	165.1	M12	19	M16	24	M16	24	M20	30
150	168.3	M12	19	M16	24	M16	24	M20	30
200	219.1	M16	24	M16(7771)	24	M16	24	M20	30
				M20(Z07)	30				
250	273.0			M20	30	M20	30	7/8"	17/16"
300	323.9			7/8"	17/16"	7/8"	17/16"	7/8"	17/16"
350	355.6			7/8"	17/16"			7/8"	17/16"
400	406.4			7/8"	17/16"			1"	15/8"
450	457.2			7/8"	17/16"			1"	15/8"
500	508.0			1"	15/8"			1"	15/8"
550	558.8			1"	15/8"			1"	15/8"
600	609.6			1"	15/8"			1"	15/8"

Note 1: 7721/7722 Mechanical tee 4" x 3" is supplied with M16 bolts.

Note 2: 7771 Rigid coupling 8" is supplied with M16 bolts and Z07 8" with M20 bolts.

XH-70EP		79		7706		7721 / 7722		723		Nominal Size
Bolt Size	Socket Size	Bolt Size	Socket Size	Bolt Size	Socket Size	Bolt Size	Socket Size	Bolt Size	Socket Size	in mm
										20
										25
								M10	17	32
		1/2"	7/8"	M10	17			M10	17	40
5/8"	1 1/16"	5/8"	1 1/16"	M10	17	M10	17	M10	17	50
5/8"	1 1/16"	5/8"	1 1/16"	M10	17	M12	19			65
				M10	17	M12	19	M10	17	65
5/8"	1 1/16"	3/4"	1 1/4"	M12	19	M12	19			80
										90
3/4"	1 1/4"	3/4"	1 1/4"	M12	19	M12	19			100
						M16	24			100
				M16	24	M16	24			125
		7/8"	1 7/16"	M16	24	M16	24			125
				M16	24	M16	24			150
7/8"	1 7/16"	7/8"	1 7/16"	M16	24	M16	24			150
1"	1 5/8"	3/4"	1 1/4"	M20	30	M20	30			200
1"	1 5/8"	7/8"	1 7/16"							250
1"	1 5/8"	1"	1 5/8"							300
		1"	1 5/8"							350
		1"	1 5/8"							400
										450
										500
										550
										600

Copper Series (Metric)

mm	Pipe Size	C305	
	Actual O.D. (BS/DIN Copper Tubing)	Bolt Size	Socket Size
50	54.0	M10	17
65	66.7	M10	17
80	76.1	M10	17
100	108.0	M12	19
125	133.0	M16	24
150	159.0	M16	24

BS Ductile Iron Pipe Series (Metric)

mm	Pipe Size	A505-BS	
	Actual O.D.	Bolt Size	Socket Size
80	98	M12	19
100	118	M16	24
150	170	M16	24

HDPE Series (Metric)

Pipe Size		H305	
Min. O.D.	Max. O.D.	Bolt Size	Socket Size
50	50.5	M10	17
63	63.6	M10	17
75	75.7	M10	17
90	90.9	M12	19
110	111.0	M12	19
140	141.3	M16	24
160	161.5	M12	24
200	201.8	M16	24
225	227.1	M16	24
250	252.3	M16	30
280	282.6	M20	30
315	317.9	M20	30

HANGERS FOR STRAIGHT RUNS

Like all other pipe joining methods, grooved piping systems require proper support to hold the weight of pipes, equipment and fluids.

For straight runs, you can use both flexible and rigid couplings. When rigid couplings are used, the same hanger spacing as other piping methods can be applied. You can refer to the hanger spacing standards of ANSI B31.1 Power Piping Code, B31.9 Building Services Piping Code, NFPA 13 Sprinkler Systems, or Mechanical Equipment Construction Guide (Japan). See the table below.

Suggested Max. Span between Supports (steel pipe)

Nominal Pipe Size	Water Service (feet/meters)				Gas or Air Service (feet/meters)		
	1)	2)	3)	4)	1)	2)	3)
in / mm							
1 / 25	7 / 2.1	9 / 2.7	12 / 3.7	6.6 / 2.0	9 / 2.7	9 / 2.7	9 / 2.7
1¼ / 32	7 / 2.1	11 / 3.4	12 / 3.7	6.6 / 2.0	9 / 2.7	9 / 2.7	11 / 3.4
1½ / 40	7 / 2.1	12 / 3.7	15 / 4.6	6.6 / 2.0	9 / 2.7	9 / 2.7	13 / 4.0
2 / 50	10 / 3.1	13 / 4.0	15 / 4.6	6.6 / 2.0	13 / 4.0	13 / 4.0	15 / 4.6
3 / 80	12 / 3.7	15 / 4.6	15 / 4.6	6.6 / 2.0	15 / 4.6	15 / 4.6	17 / 5.2
4 / 100	14 / 4.3	17 / 5.2	15 / 4.6	6.6 / 2.0	17 / 5.2	17 / 5.2	21 / 6.4
6 / 150	17 / 5.2	20 / 6.1	15 / 4.6	10 / 3.0	21 / 6.4	21 / 6.4	25 / 7.6
8 / 200	19 / 5.8	21 / 6.4	15 / 4.6	10 / 3.0	24 / 7.3	24 / 7.3	28 / 8.5
10 / 250	19 / 5.8	21 / 6.4		10 / 3.0	24 / 7.3	24 / 7.3	31 / 9.5
12 / 300	23 / 7.0	21 / 6.4		10 / 3.0	30 / 9.1	30 / 9.1	33 / 10.1
14 / 350	23 / 7.0	21 / 6.4			30 / 9.1	30 / 9.1	33 / 10.1
16 / 400	27 / 8.2	21 / 6.4			35 / 10.7	35 / 10.7	33 / 10.1
18 / 450	27 / 8.2	21 / 6.4			35 / 10.7	35 / 10.7	33 / 10.1
20 / 500	30 / 9.1	21 / 6.4			39 / 11.9	39 / 11.9	33 / 10.1
24 / 600	32 / 9.8	21 / 6.4			42 / 12.8	42 / 12.8	33 / 10.1

1) ANSI B31.1 Power Piping Code 2) ANSI B31.9 Building Services Piping Code 3) NFPA 13 Sprinkler systems
4) Ministry of Land & Transportation of Japan: Mechanical Equipment Construction Guide

NOTE: Hanger Spacing: Support of ductile iron piping systems must eliminate stress on piping joints and other components, and allow for pipe movement where required. The table below is a **SUGGESTED** maximum span for horizontal pipe runs that convey water or similar liquids. System designers must also consider special requirements for concentrated loads and areas where critical calculation have been made. Shurjoint Piping Products is not responsible for system designs.

Flexible Systems		Rigid Systems	
Size	Suggested Maximum Span	Size	Suggested Maximum Span
in / mm	Feet / Meters	in / mm	Feet / Meters
3-4	12	3-4	15
(80-100)	(3.7)	(80-100)	(4.6)
6-8	14	6-12	20
(150-200)	(4.3)	(150-300)	(6.1)
10-12	16		
(250-300)	(4.9)		

Note: Piping Systems must have at least one support per pipe length.

learn more



aalberts-ips.us

Charlotte, NC
704.841.6000



shurjoint.com

Kachsiung, TW
07.225.3768

